





Vane Type Rotary Actuators

Series Variations

Exterior		Features		Points of how to select a rotary actuator
Vane Type	CRB2 Series Size 10, 15, 20, 30, 40 	<ul style="list-style-type: none"> • Has a compact body with exterior dimensions that do not change regardless of the rotation angle, up to a maximum of 280°. 	<ul style="list-style-type: none"> • Round and compact type 	<ul style="list-style-type: none"> • Suitable for applications in which compactness of the actuator is particularly important. • Can be used as a part of a robot arm, due to its compact and lightweight package. Note) There is no protrusion in the radial direction even if a switch unit or an angle adjustment unit is installed.
	CRBU2 Series Size 10, 15, 20, 30, 40 	<ul style="list-style-type: none"> • No backlash in terms of construction. • The piping outlets are available in two directions: the body side or the axial direction. • If a double vane type is used, twice the torque of the single vane can be attained while the external configuration remains identical to that of the single vane (except for size 10). • The amount of leakage is extremely small due to the adoption of a special seal construction. 	<ul style="list-style-type: none"> • Can be mounted in the vertical, horizontal and axial directions. 	<ul style="list-style-type: none"> • Suitable for applications in which compactness of the actuator is important due to constraints in the mounting direction.
	CRB1 Series Size 50, 63, 80, 100 		<ul style="list-style-type: none"> • Even if it is equipped with an auto switch, the piping outlets are available in two directions: the body side or the axial direction. 	<ul style="list-style-type: none"> • Provides a rotation angle of up to 280° and has a large torque. Suitable for applications in which compactness of the actuator is important.
	Rotary table/High precision type MSUA Series Size 1, 3, 7, 20 		<ul style="list-style-type: none"> • Improved table top deflection 0.03 mm or less 	<ul style="list-style-type: none"> • When deflection accuracy for table top is required.
	Rotary table MSUB Series Size 1, 3, 7, 20 	<ul style="list-style-type: none"> • Has a compact body with exterior dimensions that do not change regardless of the rotation angle, up to a maximum of 190°. • No backlash in terms of construction. 	<ul style="list-style-type: none"> • A load can be mounted directly. • The rotation range can be adjusted easily. • Angle adjustment is provided as standard. • The body can be centered easily during installation. 	<ul style="list-style-type: none"> • Suitable for applications in which a table is required. • Suitable for applications in which compactness of the actuator is important due to constraints in the mounting direction. • Can be used as a part of a robot arm.

Vane Type/Rotary Actuators Series Variations

★ Conditions: 0.5 MPa

Action	Size	Rotating angle						★ Effective torque (N·m)	Speed regulation range (s/90°)	Allowable kinetic energy (J)	Page	
		90°	100°	180°	190°	270°	280°					
Single vane	10							0.12	0.03 to 0.3	0.00015	47 to 106	
	15							0.32		0.0001		
	20							0.70		0.003		
	30							1.83	0.04 to 0.3	0.020		
	40							3.73	0.07 to 0.5	0.040		
	Double vane	10							0.25	0.03 to 0.3		0.0003
		15							0.65			0.0012
		20							1.45			0.0033
30								3.70	0.04 to 0.3	0.020		
40							7.59	0.07 to 0.5	0.040			
Single vane	10							0.12	0.03 to 0.3	0.00015		
	15							0.32		0.0001		
	20							0.70		0.003		
	30							1.83	0.04 to 0.3	0.020		
	40							3.73	0.07 to 0.5	0.040		
	Double vane	10							0.25	0.03 to 0.3		0.0003
		15							0.65		0.0012	
		20							1.45		0.0033	
		30							3.70	0.04 to 0.3	0.020	
		40							7.59	0.07 to 0.5	0.040	
Single vane	50							5.69	0.1 to 1	0.082	107 to 137	
	63							10.8		0.120		
	80							18.0		0.398		
	100							35.9		0.600		
	Double vane	50								11.8		0.112
		63								22.7		0.160
		80								36.5		0.540
		100								72.6		0.811
Single vane	1							0.11	0.07 to 0.3	0.0065	139 to 170	
	3							0.31		0.017		
	7							0.69		0.042		
	20							1.78		0.073		
Single vane	1							0.11	0.07 to 0.3	0.005		
	3							0.31		0.013		
	7							0.69		0.032		
	20							1.78		0.056		
Double vane	1							0.23		0.07 to 0.3		0.005
	3							0.62				0.013
	7							1.42				0.032
	20							3.63				0.056









CRB2
CRB1
MSU
CRJ
CRA1
CRQ2
MSQ
MSZ
CRQ2X
MSQX
MRQ

D-□

- Remarks: 1. Effective torque: The values given in the table above, which are representative values, could vary according to usage conditions and thus they are not guaranteed.
 2. Adjustable speed range: If the product is used below the low-speed range, it could cause the product to stick.
 3. MSU series, Single vane type is angle adjustable $\pm 5^\circ$ at the edge of rotation of the angle range and $\pm 2.5^\circ$ for double vane type.
 4. For the MSU series, take the moment of inertia of the table in consideration in calculating the kinetic energy of the load.

Rack & Pinion Type Rotary Actuators

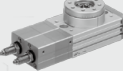
Series Variations

Exterior		Features		Points of how to select a rotary actuator	
Rack & Pinion Type	CRJB Series Size 05, 1 (Basic Type) 	<ul style="list-style-type: none"> Lightweight, compact Able to integrate the wiring and the piping in the front side or lateral side. No backlash. 	<ul style="list-style-type: none"> Can be mounted from three directions: top and bottom of the main body and the back side 	<ul style="list-style-type: none"> Suitable for applications in which compactness of the actuator is particularly important. 	
	CRJU Series Size 05, 1 (With external stopper) 	<ul style="list-style-type: none"> No backlash. 	<ul style="list-style-type: none"> Can be mounted from two directions: bottom of the main body and the back side Angle adjustment is possible. 	<ul style="list-style-type: none"> Suitable for applications in which compactness of the actuator is particularly important. When angle adjustment is required. 	
	CRA1 Series Size 30, 50, 63, 80, 100 	<ul style="list-style-type: none"> Can be used at relatively slower speeds, as compared with the vane type. Can be selected with air cushion. 	<ul style="list-style-type: none"> A compact auto switch (D-M9□ type) can be mounted. There is a slight backlash of less than 1° due to the single piston construction. A wide variety, from small to large models, are available. These can be used with the air-hydro specifications. (Except size 30) 	<ul style="list-style-type: none"> Suitable for applications that require a wide range of speed adjustment. Suitable for air-hydro applications. 	
	CRQ2 Series Size 10, 15, 20, 30, 40 	(CRQ2: 10, 15 excepted)	<ul style="list-style-type: none"> There is no backlash because the double piston type has been adopted. 	<ul style="list-style-type: none"> Suitable for applications in which a thin profile is required. Suitable for applications requiring no backlash. 	
	Rotary table MSQ Series Size 1, 2, 3, 7, 10, 20, 30, 50, 70, 100, 200 	<ul style="list-style-type: none"> A thin rotary table unit with a low table top height. No backlash. Piping direction is selectable from the edge side of the main body and the lateral side. Actuator with internal shock absorber is selectable. (Size 10, 20, 30, 50, 70, 100, 200) Actuator with external shock absorber is selectable. (Size 10, 20, 30, 50) 	<ul style="list-style-type: none"> The body can be centered easily during installation. A load can be mounted directly. The angle can be adjusted as desired. (Between 0° and 190°) (Adjustor bolt, internal absorber) The body can be used as a flange. 	<ul style="list-style-type: none"> Suitable for applications in which a table is required. Suitable for applications in which a thin profile is required particularly. Suitable for applications requiring no backlash. 	
	Size 10, 20, 30, 50 (With external shock absorber) 				
	3-position rotary table MSZ Series Size 10, 20, 30, 50 	<ul style="list-style-type: none"> Can be controlled with a solenoid valve located in the 3 position pressure center. No backlash. 	<ul style="list-style-type: none"> Right and left rotation ends can be adjustable at 0 to 95° from the central position. 	<ul style="list-style-type: none"> Suitable for 3 position stopping. 	
	Low-speed rotary actuator CRQ2X Series Size 10, 15, 20, 30, 40 	<ul style="list-style-type: none"> Stable operation possible at 5 s/90°. 	<ul style="list-style-type: none"> Dimensions the same as CRQ2 series. 	<ul style="list-style-type: none"> Suitable for low-speed operation. 	
Low-speed rotary table MSQX Series Size 10, 20, 30, 50 		<ul style="list-style-type: none"> Dimensions the same as MSQ series. 			

Rotary cylinder

MRQ Series

Size 32, 40
p. 343 to 361

A direct rotary unit in which a thin cylinder and a rotary actuator have been integrated in a compact package.



- Rotation angle/80 to 100°, 170 to 190°
- Linear stroke/5, 10, 15, 20, 25, 30, 40, 50, 75, 100 mm

Rack & Pinion Type/Rotary Actuators Series Variations

★ Conditions: 0.5 MPa

Action	Size	Rotating angle					★ Effective torque (N·m)	Speed regulation range (s/90°)	Allowable kinetic energy (J)	Page	
		90°	100°	180°	190°	360°					
Single rack pinion	05						0.042	0.1 to 0.5	0.00025	171 to 182	
	1						0.095		0.001		
	05						0.042	0.1 to 0.5	0.0004		
	1						0.095		0.002		
Single rack pinion	30						1.91	0.2 to 1	0.010	183 to 232	
	50						9.27	0.2 to 2	0.050		
	63						17.2	0.2 to 3	0.98 * 0.12		
	80						31.7	0.2 to 4	1.5 * 0.16		
	100							74.3	0.2 to 5		2.0 * 0.54
											2.9 *
Double rack pinion	10						0.3	0.2 to 0.7	0.00025	233 to 260	
	15						0.75		0.00039		
	20						1.84	0.2 to 1	0.025		
	30						3.11		0.12 * 0.048		
	40								5.3		0.25 * 0.081
											0.4 *
Double rack pinion	1						0.087	0.2 to 0.7	0.001	261 to 286	
	2						0.18		0.0015		
	3						0.29		0.002		
	7						0.56	0.2 to 1	0.006		
	10						0.89	0.2 to 1 (With shock absorber: 0.2 to 0.7)	0.007		
	20								1.84		0.039 * 0.025
											0.116 * 0.048
	30						2.73		0.116 * 0.081		
	50						4.64		0.081 0.294 *		
	70						6.79		0.2 to 1.5 (With shock absorber: 0.2 to 1)		0.24 1.1 *
	100						10.1	0.2 to 2 (With shock absorber: 0.2 to 1)	0.32 1.6 *		
	200						19.8	0.2 to 2.5 (With shock absorber: 0.2 to 1)	0.56 2.9 *		
Double rack pinion	10						0.90	0.2 to 1	0.007	287 to 299	
	20						1.78		0.025		
	30						2.65		0.048		
	50						4.75		0.081		
Double rack pinion	10						0.3	0.7 to 5	0.00025	301 to 341	
	15						0.75		0.00039		
	20						1.84		0.025		
	30						3.11	0.048			
	40						5.3	0.081			
Double rack pinion	10						0.89	1 to 5	0.007		
	20						1.84		0.025		
	30						2.73		0.048		
	50						4.64		0.081		

Remarks: 1. Effective torque: The values given in the table above, which are representative values, could vary according to usage conditions and thus they are not guaranteed.

2. Adjustable speed range: If the product is used at a speed lower than the adjustment range, it may cause the product to stick or stop.

3. Allowable energy:

* Symbol: The * symbol in the allowable energy for the CRA1 series and the CRQ2 series indicates the value of an actuator that is equipped with an air cushion.

For the MSQ series, the * symbol indicates the value of an actuator that is equipped with a shock absorber.

4. Refer to page 279 for allowable energy of the external shock absorber type (L type, H type) for the MSQ series.

CRB2
CRB1
MSU
CRJ
CRA1
CRQ2
MSQ
MSZ
CRQ2X
MSQX
MRQ

D-□

Working Principle

Rack & Pinion Type

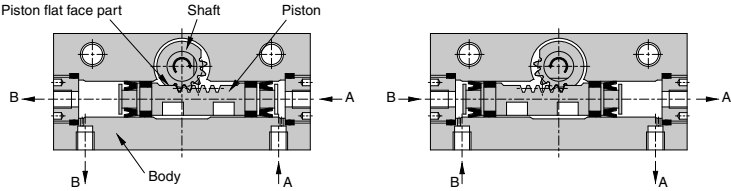
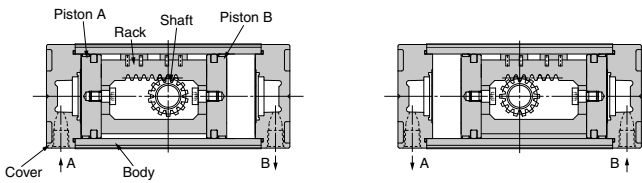
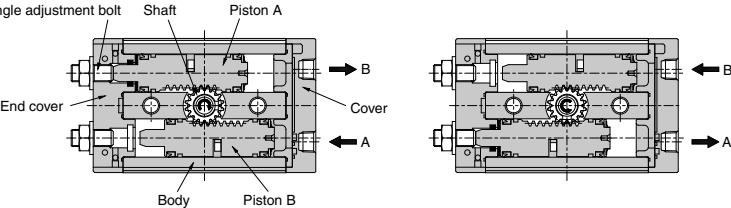
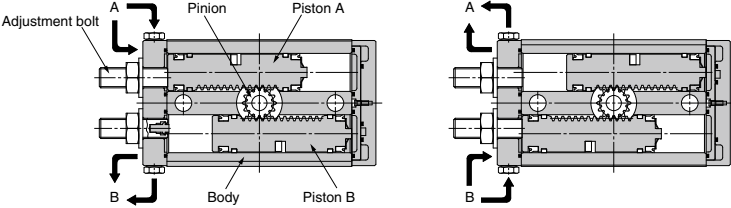
Series	Working principle
CRJ	 <ol style="list-style-type: none"> 1. It consists of the piston, which is integrated with rack which travels inside the main body of cylinder and the shaft. 2. If air is supplied from the A port, the right side of piston is pushed, it then generates the torque via rack and pinion. 3. The air in the exhaust chamber discharges via port B and rotates clockwise. 4. When a part of the shaft contacts the piston flat face part, the revolution stops. 5. Similarly, when air is supplied from port B, it rotates counterclockwise.
CRA1	 <ol style="list-style-type: none"> 1. It consists of 2 pistons that slide in the cylinder body, a rack that is sandwiched between the pistons, and a shaft. 2. The air that is supplied from port A pushes piston A, and this force is transmitted via the shaft to generate torque in the shaft. 3. The air in the exhaust chamber discharges via port B and rotates clockwise. 4. The shaft stops when piston B comes in contact with the cover and stops. 5. Similarly, when air is supplied from port B, it rotates counterclockwise.
CRQ2	 <ol style="list-style-type: none"> 1. It consists of a rack that slides in 2 parallel cylinders, 2 pistons that are integrated with the rack, and a shaft. 2. The air that is supplied from port A pushes the right side of piston B; at the same time, it passes through the air passage of the body, pushing the left side of piston A, thus creating in the shaft a torque that is equivalent to 2 pistons. 3. The air in the exhaust chamber discharges via port B and rotates clockwise. 4. The shaft stops when piston B comes in contact with the angle adjustment bolt and stops. 5. Similarly, when air is supplied from port B, it rotates counterclockwise.
MSQ	 <ol style="list-style-type: none"> 1. It consists of a rack that slides in 2 parallel cylinders, 2 pistons that are integrated with the rack, and a pinion. 2. The air that is supplied from port A pushes the left side of piston A; at the same time, it passes through the air passage of the body, pushing the right side of piston B, thus creating in the shaft an amount of torque that is equivalent to 2 pistons. 3. The air in the exhaust chamber discharges via port B and rotates clockwise. 4. The pinion stops when piston B comes in contact with the adjustment bolt and stops. 5. Similarly, when air is supplied from port B, it rotates counterclockwise.

Working Principle: How to Mount Loads

Vane Type

Series	Single vane (S)	Double vane (D)
CRB2 CRB1 CRBU2 MSU	<ol style="list-style-type: none"> It consists of a shaft that is integrated with the vane that slides along the inner surface of the body, and a stopper. The air that is supplied from port A pushes the vane, thus creating torque in the shaft. The air in the exhaust chamber discharges via port B and rotates clockwise. The vane stops as it comes in contact with the stopper. Similarly, when air is supplied from port B, it rotates counterclockwise. 	<ol style="list-style-type: none"> It consists of a shaft that is integrated with the 2 vanes that slide along the inner surface and 2 stoppers. The air that is supplied in the shaft in order to also supply air to the other chamber. Thus, the air pushes 2 vanes and creates torque in the shaft. Its movement consists of the same rotation as that of the single vane.

CRB2
 CRB1
 MSU
 CRJ
 CRA1
 CRQ2
 MSQ
 MSZ
 CRQ2X
 MSQX
 MRQ

How to Mount Loads

How to connect a load directly to a single flat shaft

To secure the load, select a bolt of an appropriate size from those listed in tables 1 and 2 by taking the shaft's single flat bearing stress strength into consideration.

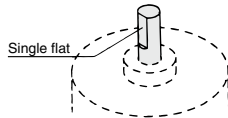

Table (1) Directly Fixed with Bolts (Refer to Figure (1).)

Model	Size	Shaft bore size	Screw
CRQ2	10	5	M5 or larger
	15	6	
CRB2	10	4	M4 or larger
	15	5	M5 or larger
	20	6	M5 or larger
	30	8	M6 or larger
CRBU2	10	4	M4 or larger
	15	5	M5 or larger
	20	6	M5 or larger
	30	8	M6 or larger
CRJ	05	5	M5 or larger
	1	6	

Table (2) Fixed with a Holding Block (Refer to Figure (2).)

Model	Size	Shaft bore size	Screw	Plate thickness (t)
CRQ2	10	5	M3 or larger	2.3 or wider
	15	6	M4 or larger	3.6 or wider
CRB2	10	4	M3 or larger	2 or wider
	15	5	M3 or larger	2.3 or wider
	20	6	M4 or larger	3.6 or wider
	30	8	M5 or larger	4 or wider
CRBU2	10	4	M3 or larger	2 or wider
	15	5	M3 or larger	2.3 or wider
	20	6	M4 or larger	3.6 or wider
	30	8	M5 or larger	4 or wider
CRJ	05	5	M3 or larger	2.3 or wider
	1	6	M4 or larger	3.6 or wider

The plate thickness (t) in the table above indicates a reference value when a carbon steel is used. Besides, we do not manufacture a holding block.

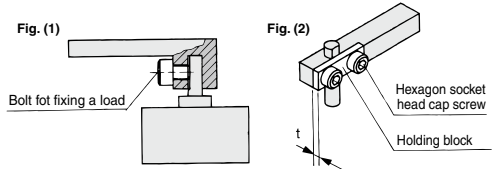

D-□

Rotary Actuators

Model Selection

① Calculation of Moment of Inertia	P.24
①-1 Equation Table of Moment of Inertia	P.25
①-2 Calculation Example of Moment of Inertia	P.26
①-3 Graph for Calculating the Moment of Inertia	P.28
② Calculation of Required Torque	P.30
②-1 Load Type	P.30
②-2 Effective Torque	P.31
②-3 Effective Torque for Each Equipment	P.31
③ Confirmation of Rotation Time	P.33
④ Calculation of Kinetic Energy	P.34
④-1 Allowable Kinetic Energy and Rotation Time Adjustment Range ...	P.35
④-2 Moment of Inertia and Rotation Time	P.36
⑤ Confirmation of Allowable Load	P.39
⑥ Calculation of Air Consumption and Required Air Flow Capacity ...	P.40
⑥-1 Inner Volume and Air Consumption	P.41
⑥-2 Air Consumption Calculation Graph	P.43

Rotary Actuators Model Selection

(Refer to pages 302 to 307 for the selection of low-speed rotary actuators **CRQ2X/MSQX** series.

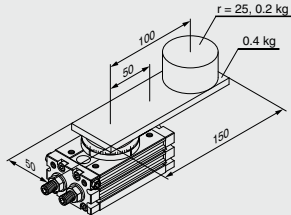
Selection Procedures	Note	Selection Example
<p>◆ Operating conditions are as follows:</p>		
<p>Operating conditions are as follows:</p> <ul style="list-style-type: none"> Tentative models Operating pressure (MPa) Mounting orientation Load type <ul style="list-style-type: none"> Static load Resistance load Inertial load Load dimensions (m) Load mass (kg) Rotation time (s) Rotation angle (rad) 	<ul style="list-style-type: none"> Refer to page 30 for the load type. The unit for the rotation angle is radian. <ul style="list-style-type: none"> $180^\circ = \pi \text{ rad}$ $90^\circ = \pi/2 \text{ rad}$ 	 <p>Tentative model: MSQB30A Operating pressure: 0.3 MPa Mounting orientation: Vertical Load type: Inertial load Rotation time: $t = 1.5\text{s}$ Rotation angle: $\theta = \pi \text{ rad} (180^\circ)$</p>
<p>1 Calculation of Moment of Inertia</p>		
<p>Calculate the inertial moment of load. ⇒P.24</p>	<ul style="list-style-type: none"> Loads are generated from multiple parts. The inertial moment of each load is calculated, and then totaled. 	<p>Inertial moment of load 1 I_1:</p> $I_1 = 0.4 \times \frac{0.15^2 + 0.05^2}{12} + 0.4 \times 0.05^2 = 0.001833$ <p>Inertial moment of load 2 I_2:</p> $I_2 = 0.2 \times \frac{0.025^2}{2} + 0.2 \times 0.1^2 = 0.002063$ <p>Total inertial moment I</p> $I = I_1 + I_2 = 0.003896 \text{ [kg}\cdot\text{m}^2\text{]}$
<p>2 Calculation of Required Torque</p>		
<p>Calculate the required torque for each load type and confirm whether the values fall in the effective torque range.</p> <ul style="list-style-type: none"> Static load (Ts) Required torque: $T = Ts$ Resistance load (Tf) Required torque: $T = Tf (3 \text{ to } 5)$ Inertial load (Ta) Required torque: $T = Ta \times 10$ <p>⇒P.30</p>	<ul style="list-style-type: none"> When the resistance load is rotated, the required torque calculated from the inertial load must be added. <p>Required torque</p> $T = Tf \times (3 \text{ to } 5) + Ta \times 10$	<p>Inertial load: Ta</p> $Ta = I \cdot \omega$ $\omega = \frac{2\theta}{t^2} \text{ [rad/s}^2\text{]}$ <p>Required torque: T</p> $T = Ta \times 10$ $= 0.003896 \times \frac{2 \times \pi}{1.5^2} \times 10 = 0.109 \text{ [N}\cdot\text{m]}$ <p>0.109 Nm < Effective torque OK</p>
<p>3 Confirmation of Rotation Time</p>		
<p>Confirm whether the time falls in the rotation time adjustment range. ⇒P.33</p>	<ul style="list-style-type: none"> Consider the time after converted in the time per 90°. ($1.0 \text{ s}/180^\circ$ is converted in $0.5 \text{ s}/90^\circ$.) 	$0.2 \leq t \leq 1.0$ $t = 0.75\text{s}/90^\circ\text{OK}$
<p>4 Calculation of Kinetic Energy</p>		
<p>Calculate the kinetic energy of the load and confirm whether the energy is below the allowable range. Can confirm referring to the inertial moment and rotation time graph. (Pages 36 to 38) ⇒P.34</p>	<ul style="list-style-type: none"> If the energy exceeds the allowable range, a suitable cushioning mechanism such as a shock absorber must be externally installed. 	<p>Kinetic energy: E</p> $E = \frac{1}{2} I \cdot \omega^2$ $\omega = \frac{2\theta}{t}$ $E = \frac{1}{2} \cdot 0.003896 \times \left(\frac{2 \times \pi}{1.5} \right)^2 = 0.03414 \text{ [J]}$ <p>0.03414 [J] < Allowable energy OK</p>
<p>5 Confirmation of Allowable Load</p>		
<p>Confirm whether the load applied to the product is within the allowable range. ⇒P.39</p>	<ul style="list-style-type: none"> If the load exceeds the allowable range, a bearing or similar must be externally installed. 	<p>Moment load: M</p> $M = 0.4 \times 9.8 \times 0.05 + 0.2 \times 9.8 \times 0.1$ $= 0.392 \text{ [N}\cdot\text{m]}$ <p>0.392 [N·m] < Allowable moment load OK</p>
<p>6 Calculation of Air Consumption and Required Air Flow Capacity</p>		
<p>Air consumption and required air flow capacity are calculated when necessary. ⇒P.40</p>		

- CRB□2
- CRB1
- MSU
- CRJ
- CRA1
- CRQ2
- MSQ
- MSZ
- CRQ2X
- MSQX
- MRQ

D-□

Rotary Actuators Model Selection

① Calculation of Moment of Inertia

The moment of inertia is a value indicating the inertia of a rotating body, and expresses the degree to which the body is difficult to rotate, or difficult to stop.

It is necessary to know the moment of inertia of the load in order to determine the value of necessary torque or kinetic energy when selecting a rotary actuator.

Moving the load with the actuator creates kinetic energy in the load. When stopping the moving load, it is necessary to absorb the kinetic energy of the load with a stopper or a shock absorber. The kinetic energy of the load can be calculated using the formulas shown in Figure 1 (for linear motion) and Figure 2 (for rotation motion).

In the case of the kinetic energy for linear motion, the formula (1) shows that when the velocity v is constant, it is proportional to the mass m . In the case of rotation motion, the formula (2) shows that when the angular velocity is constant, it is proportional to the moment of inertia.

Linear motion



$$E = \frac{1}{2} \cdot m \cdot V^2 \dots\dots\dots(1)$$

E : Kinetic energy
m : Load mass
V : Speed

Fig. (1) Linear motion

Rotation motion

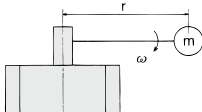

$$E = \frac{1}{2} \cdot I \cdot \omega^2 = \frac{1}{2} \cdot m \cdot r^2 \cdot \omega^2 \dots\dots(2)$$

E : Kinetic energy
I : Moment of inertia (= $m \cdot r^2$)
ω : Speed
m : Mass
r : Radius of rotation

Fig. (2) Rotation motion

As the moment of inertia is proportional to the squares of the mass and the radius of rotation, even when the load mass is the same, the moment of inertia will be squared as the radius of rotation grows bigger. This will create greater kinetic energy, which may result in damage to the product.

When there is rotation motion, product selection should be based not on the load mass of the load, but on the moment of inertia.

Moment of Inertia Formula

The basic formula for obtaining a moment of inertia is shown below.

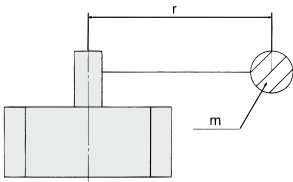

$$I = m \cdot r^2$$

m : Mass
r : Radius of rotation

This formula represents the moment of inertia for the shaft with mass m , which is located at distance r from the shaft. For actual loads, the values of the moment of inertia are calculated depending on configurations, as shown on the following page.

- ⇒P.25 Equation table of moment of inertia
- ⇒P.26 and 27 Calculation example of moment of inertia
- ⇒P.28 and 29 Graph for calculating the moment of inertia

1-1 Equation Table of Moment of Inertia

I: Moment of inertia m: Load mass

1. Thin shaft

Position of rotational axis: Perpendicular to the shaft through the center of gravity

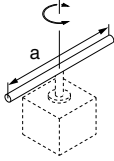

$$I = m \cdot \frac{a^2}{12}$$

2. Thin rectangular plate

Position of rotational axis: Parallel to side b and through the center of gravity

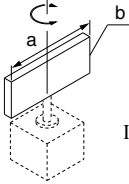

$$I = m \cdot \frac{a^2}{12}$$

3. Thin rectangular plate (Including Rectangular parallelepiped)

Position of rotational axis: Perpendicular to the plate through the center of gravity

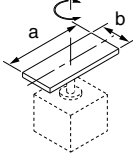

$$I = m \cdot \frac{a^2 + b^2}{12}$$

4. Round plate (Including column)

Position of rotational axis: Through the center axis

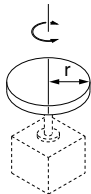

$$I = m \cdot \frac{r^2}{2}$$

5. Solid sphere

Position of rotational axis: Through the center of diameter

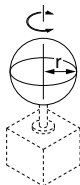

$$I = m \cdot \frac{2r^2}{5}$$

6. Thin round plate

Position of rotational axis: Through the center of diameter

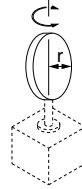

$$I = m \cdot \frac{r^2}{4}$$

7. Cylinder

Position of rotational axis: Through the center of diameter and gravity.

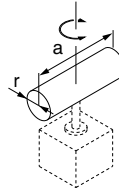

$$I = m \cdot \frac{3r^2 + a^2}{12}$$

8. When the rotational axis and load center of gravity are not consistent

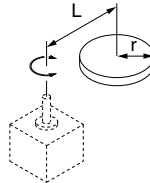

$$I = K + m \cdot L^2$$

K: Moment of inertia around the load center of gravity

4. Round plate $K = m \cdot \frac{r^2}{2}$

9. Gear transmission

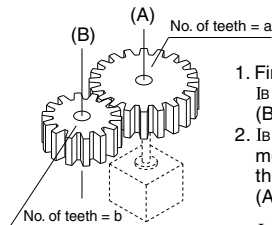

1. Find the moment of inertia I_B for the rotation of shaft (B).
2. I_B is converted to the moment of inertia I_A for the rotation of the shaft (A).

$$I_A = \left(\frac{a}{b}\right)^2 \cdot I_B$$

CRB□2
CRB1
MSU
CRJ
CRA1
CRQ2
MSQ
MSZ
CRQ2X MSQX
MRQ

D-□

Rotary Actuators Model Selection

1-2 Calculation Example of Moment of Inertia

1 If the shaft is located at a desired point of the load:

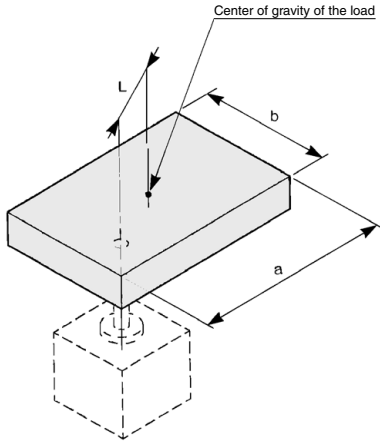

Example: ① If the load is the thin rectangular plate:

Obtain the center of gravity of the load as I_1 , a provisional shaft.

$$I_1 = m \cdot \frac{a^2 + b^2}{12}$$

② Obtain the actual moment of inertia I_2 around the shaft, with the premise that the mass of the load itself is concentrated in the load's center of gravity point.

$$I_2 = m \cdot L^2$$

③ Obtain the actual moment of inertia I .

$$I = I_1 + I_2$$

$$\left(\begin{array}{l} m: \text{mass of the load} \\ L: \text{distance from the shaft to the load's} \\ \text{center of gravity} \end{array} \right)$$

Calculation Example

$$a = 0.2 \text{ m}, b = 0.1 \text{ m}, L = 0.05 \text{ m}, m = 1.5 \text{ kg}$$

$$I_1 = 1.5 \times \frac{0.2^2 + 0.1^2}{12} = 6.25 \times 10^{-3} \quad \text{kg} \cdot \text{m}^2$$

$$I_2 = 1.5 \times 0.05^2 = 3.75 \times 10^{-3} \quad \text{kg} \cdot \text{m}^2$$

$$I = (6.25 + 3.75) \times 10^{-3} = 0.01 \quad \text{kg} \cdot \text{m}^2$$

2 If the load is divided into multiple loads:

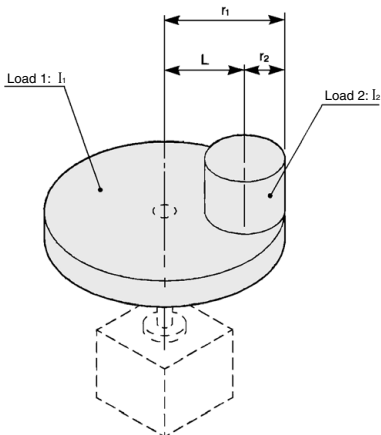

Example: ① If the load is divided into the 2 cylinders:

$\left\{ \begin{array}{l} \text{The center of gravity of load 1 matches the shaft} \\ \text{The center of gravity of load 2 differs from the shaft} \end{array} \right\}$
Obtain the moment of inertia of load 1:

$$I_1 = m_1 \cdot \frac{r_1^2}{2}$$

② Obtain the moment of inertia of load 2:

$$I_2 = m_2 \cdot \frac{r_2^2}{2} + m_2 \cdot L^2$$

③ Obtain the actual moment of inertia I :

$$I = I_1 + I_2$$

$$\left(\begin{array}{l} m_1, m_2: \text{mass of loads 1, and 2} \\ r_1, r_2: \text{radius of loads 1, and 2} \\ L: \text{distance from the shaft to the center of gravity of load 2} \end{array} \right)$$

Calculation Example

$$m_1 = 2.5 \text{ kg}, m_2 = 0.5 \text{ kg}, r_1 = 0.1 \text{ m}, r_2 = 0.02 \text{ m}, L = 0.08 \text{ m}$$

$$I_1 = 2.5 \times \frac{0.1^2}{2} = 1.25 \times 10^{-2} \quad \text{kg} \cdot \text{m}^2$$

$$I_2 = 0.5 \times \frac{0.02^2}{2} + 0.5 \times 0.08^2 = 0.33 \times 10^{-2} \quad \text{kg} \cdot \text{m}^2$$

$$I = (1.25 + 0.33) \times 10^{-2} = 1.58 \times 10^{-2} \quad \text{kg} \cdot \text{m}^2$$

3 If a lever is attached to the shaft and a cylinder and a gripper are mounted to the tip of the lever:

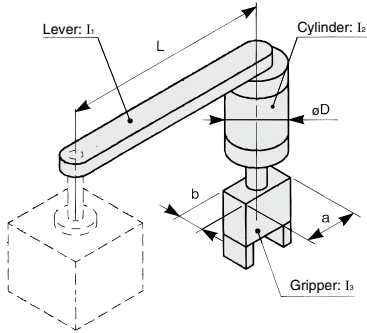

Example: ① Obtain the lever's moment of inertia:

$$I_1 = m_1 \cdot \frac{L^2}{3}$$

② Obtain the cylinder's moment of inertia:

$$I_2 = m_2 \cdot \frac{(D/2)^2}{2} + m_2 \cdot L^2$$

③ Obtain the gripper's moment of inertia:

$$I_3 = m_3 \cdot \frac{a^2 + b^2}{12} + m_3 \cdot L^2$$

④ Obtain the actual moment of inertia:

$$I = I_1 + I_2 + I_3$$

(m_1 : mass of lever
 m_2 : mass of cylinder
 m_3 : mass of gripper)

Calculation Example

$L = 0.2 \text{ m}$, $\phi D = 0.06 \text{ m}$, $a = 0.06 \text{ m}$, $b = 0.03 \text{ m}$, $m_1 = 0.5 \text{ kg}$, $m_2 = 0.4 \text{ kg}$, $m_3 = 0.2 \text{ kg}$

$$I_1 = 0.5 \times \frac{0.2^2}{3} = 0.67 \times 10^{-2} \quad \text{kg} \cdot \text{m}^2$$

$$I_2 = 0.2 \times \frac{0.06^2 + 0.03^2}{12} + 0.2 \times 0.2^2 = 0.81 \times 10^{-2} \quad \text{kg} \cdot \text{m}^2$$

$$I_3 = 0.4 \times \frac{(0.06/2)^2}{8} + 0.4 \times 0.2^2 = 1.62 \times 10^{-2} \quad \text{kg} \cdot \text{m}^2$$

$$I = (0.67 + 1.62 + 0.81) \times 10^{-2} = 3.1 \times 10^{-2} \quad \text{kg} \cdot \text{m}^2$$

4 If a load is rotated through the gears:

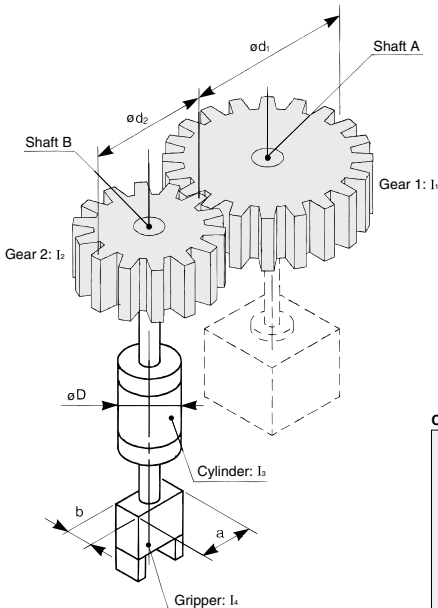

Example: ① Obtain the moment of inertia I_1 around shaft A:

$$I_1 = m_1 \cdot \frac{(d_1/2)^2}{2}$$

② Obtain moment of inertias I_2 , I_3 and I_4 around shaft B:

$$I_2 = m_2 \cdot \frac{(d_2/2)^2}{2} \quad I_3 = m_3 \cdot \frac{(D/2)^2}{2}$$

$$I_4 = m_4 \cdot \frac{a^2 + b^2}{12} \quad I_5 = I_2 + I_3 + I_4$$

③ Replace the moment of inertia I_2 around shaft B with the moment of inertia I_6 around shaft A.

$$I_6 = (A/B)^2 \cdot I_2 \quad [A/B: \text{ratio of the number of teeth}]$$

④ Obtain the actual moment of inertia:

$$I = I_1 + I_6$$

(m_1 : mass of gear 1
 m_2 : mass of gear 2
 m_3 : mass of cylinder
 m_4 : mass of gripper)

Calculation Example

$d_1 = 0.1 \text{ m}$, $d_2 = 0.05 \text{ m}$, $D = 0.04 \text{ m}$, $a = 0.04 \text{ m}$, $b = 0.02 \text{ m}$
 $m_1 = 1 \text{ kg}$, $m_2 = 0.4 \text{ kg}$, $m_3 = 0.5 \text{ kg}$, $m_4 = 0.2 \text{ kg}$, tooth count ratio = 2

$$I_1 = 1 \times \frac{(0.1/2)^2}{2} = 1.25 \times 10^{-3} \text{ kg} \cdot \text{m}^2 \quad I_2 = 0.2 \times \frac{0.04^2 + 0.02^2}{12} = 0.03 \times 10^{-3} \text{ kg} \cdot \text{m}^2$$

$$I_3 = 0.4 \times \frac{(0.05/2)^2}{2} = 0.13 \times 10^{-3} \text{ kg} \cdot \text{m}^2 \quad I_4 = (0.13 + 0.1 + 0.03) \times 10^{-3} = 0.26 \times 10^{-3} \text{ kg} \cdot \text{m}^2$$

$$I_5 = 0.5 \times \frac{(0.04/2)^2}{2} = 0.1 \times 10^{-3} \text{ kg} \cdot \text{m}^2 \quad I_6 = 2^2 \times 0.26 \times 10^{-3} = 1.04 \times 10^{-3} \text{ kg} \cdot \text{m}^2$$

$$I = (1.25 + 1.04) \times 10^{-3} = 2.29 \times 10^{-3} \text{ kg} \cdot \text{m}^2$$

Rotary Actuators Model Selection

1-3 Graph for Calculating the Moment of Inertia

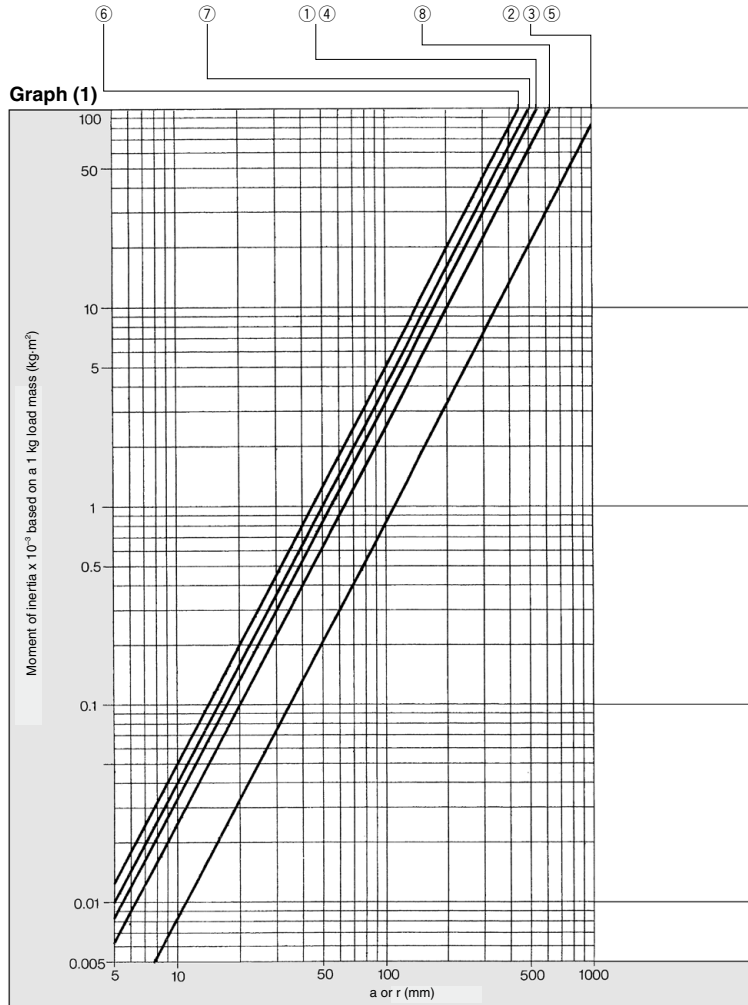
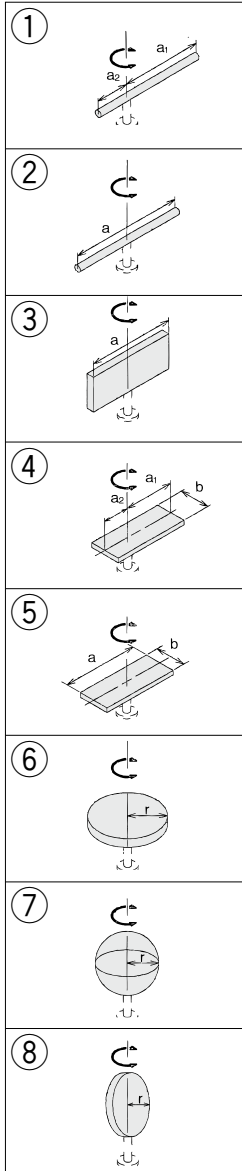

How to read the graph: only when the dimension of the load is "a" or "r"

[Example] When the load shape is ②, $a = 100$ mm, and the load mass is 0.1 kg. In Graph (1), the point at which the vertical line of $a = 100$ mm and the line of the load shape ② intersect indicates that the moment of inertia of the 1 kg mass is 0.83×10^{-3} kg·m².

Because the mass of the load is 0.1 kg, the actual moment of inertia is $0.83 \times 10^{-3} \times 0.1 = 0.083 \times 10^{-3}$ kg·m².

(Note: If "a" is divided into "a₁a₂", the moment of inertia can be obtained by calculating them separately.)

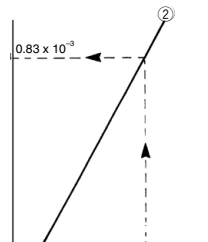

Rotary Actuators Model Selection

Graph (2)

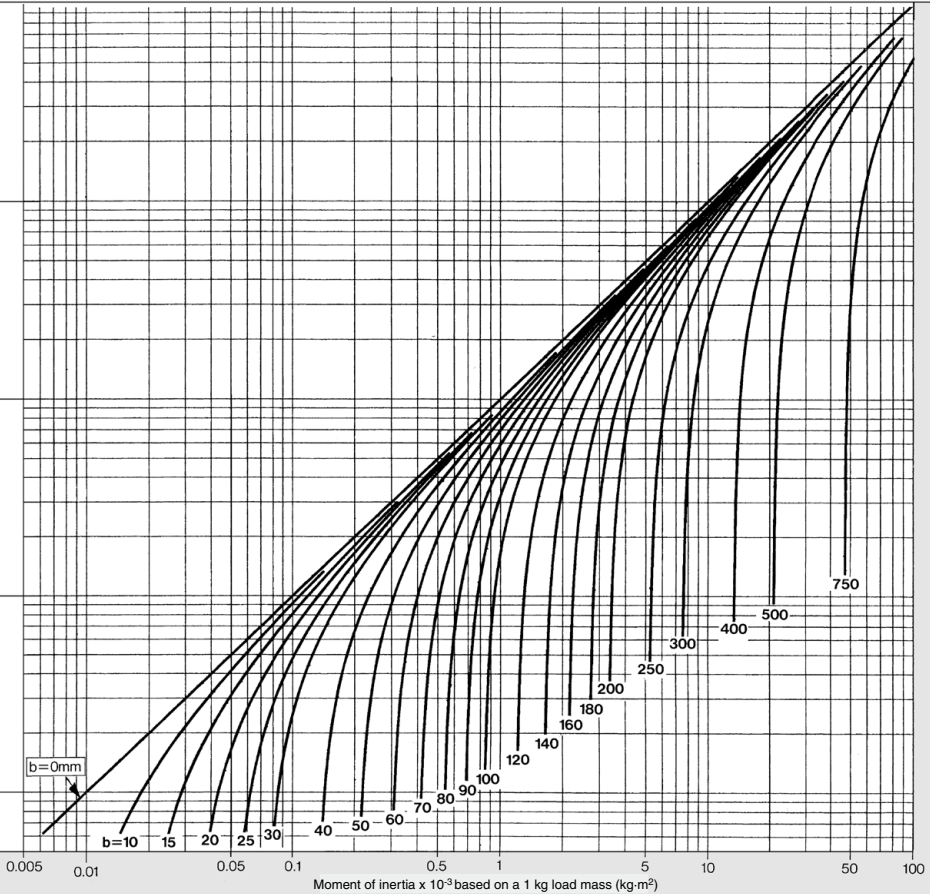

- CRB□2
- CRB1
- MSU
- CRJ
- CRA1
- CRQ2
- MSQ
- MSZ
- CRQ2X
- MSQX
- MRQ

How to read the graph: when the dimension of the load contains both "a" and "b".

[Example] When the load shape is ⑤, a = 100 mm, b = 100 mm, and the load mass is 0.5 kg.

In Graph (1), obtain the point at which the vertical line of a = 100 mm and the line of the load shape ⑤ intersect. Move this intersection point to Graph (2), and the point at which it intersects with the curve of b = 100 mm indicates that the moment of inertia of the 1 kg mass is $1.7 \times 10^{-3} \text{ kg}\cdot\text{m}^2$.

Since the load mass is 0.5 kg, the actual moment of inertia is $1.7 \times 10^{-3} \times 0.5 = 0.85 \times 10^{-3} \text{ kg}\cdot\text{m}^2$.

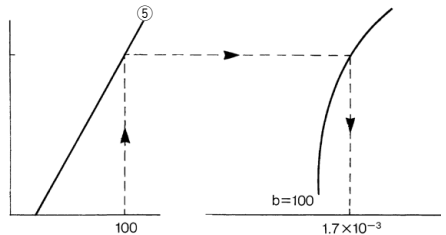

D-□

Rotary Actuators Model Selection

② Calculation of Required Torque

②-1 Load Type

The calculation method of required torque varies depending on the load type. Obtain the required torque referring to the table below.

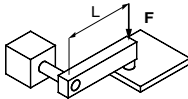
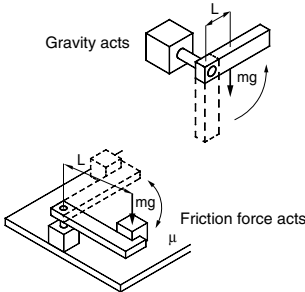
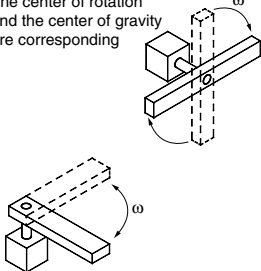
Load type		
Static load: T_s	Resistance load: T_f	Inertial load: T_a
When the pressing force is necessary (clamp, etc.)	When friction force or gravity is applied to the rotation direction	When the load with inertia is rotated
		
$T_s = F \cdot L$ T_s : Static load (N·m) F : Clamp force (N) L : Distance from the center of rotation to clamp (m)	When gravity acts to the rotation direction $T_f = m \cdot g \cdot L$ When friction force acts to the rotation direction $T_f = \mu \cdot m \cdot g \cdot L$ T_f : Resistance load (N·m) m : Mass of load (kg) g : Gravitational acceleration 9.8 (m/s ²) L : Distance from the center of rotation to the gravity or friction force acting point (m) μ : Coefficient of friction	$T_a = I \cdot \dot{\omega} = I \cdot \frac{2\theta}{t^2}$ T_a : Inertial load (N·m) I : Moment of inertia (kg·m ²) $\dot{\omega}$: Angular acceleration (rad/s ²) θ : Rotating angle (rad) t : Rotation time (s)
Required torque $T = T_s$	Required torque $T = T_f \times (3 \text{ to } 5)$ <small>Note 1)</small>	Required torque $T = T_a \times 10$ <small>Note 1)</small>
<p>• Resistance loads → Gravity or friction applies in the rotation direction. Example 1) The axis of rotation is in a horizontal (lateral) direction, and the center of rotation and center of gravity of the load are not the same. Example 2) The load slips against the floor while rotating. *The necessary torque equals the total of the resistance load and inertial load. $T = T_f \times (3 \text{ to } 5) + T_a \times 10$</p> <p>• Non-resistance loads → Gravity or friction does not apply in the rotation direction. Example 1) The axis of rotation is in a perpendicular (vertical) direction. Example 2) The axis of rotation is in a horizontal (lateral) direction, and the center of rotation and center of gravity of the load are the same. *The necessary torque equals the inertial load only. $T = T_a \times 10$</p>		

Note 1) In order to adjust the velocity, it is necessary to have a margin of adjustment for T_f and T_a .

⇒P.31 Effective torque
 ⇒P.31 and 32 Effective torque for each equipment

Rotary Actuators Model Selection

2-2 Effective Torque

Graph (3) CRB2/CRBU2/CRB1/MSU Series

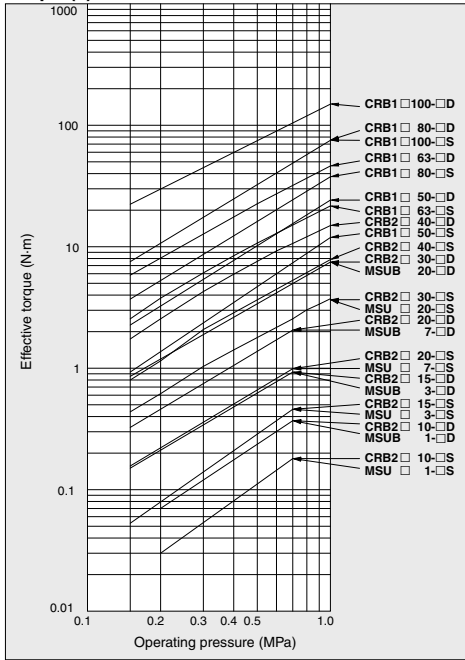

Graph (4) CRA1/CRQ2/MSQ/CRJ Series

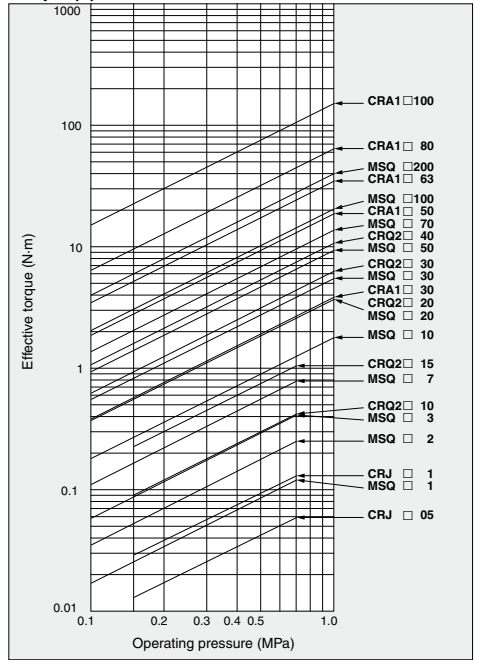

- CRB□2
- CRB1
- MSU
- CRJ
- CRA1
- CRQ2
- MSQ
- MSZ
- CRQ2X
- MSQX
- MRQ

2-3 Effective Torque for Each Equipment

Vane Type: CRB2/CRBU2/CRB1 Series



Size	Vane type	Operating pressure (MPa)									
		0.15	0.2	0.3	0.4	0.5	0.6	0.7	0.8	0.9	1.0
10	Single vane	—	0.03	0.06	0.09	0.12	0.15	0.18	—	—	—
	Double vane	—	0.07	0.13	0.19	0.25	0.31	0.37	—	—	—
15	Single vane	0.06	0.10	0.17	0.24	0.32	0.39	0.46	—	—	—
	Double vane	0.13	0.20	0.34	0.48	0.65	0.79	0.93	—	—	—
20	Single vane	0.16	0.23	0.39	0.54	0.70	0.84	0.99	—	—	—
	Double vane	0.33	0.47	0.81	1.13	1.45	1.76	2.06	—	—	—
30	Single vane	0.44	0.62	1.04	1.39	1.83	2.19	2.58	3.03	3.40	3.73
	Double vane	0.90	1.26	2.10	2.80	3.70	4.40	5.20	6.09	6.83	7.49
40	Single vane	0.81	1.21	2.07	2.90	3.73	4.55	5.38	6.20	7.03	7.86
	Double vane	1.78	2.58	4.30	5.94	7.59	9.24	10.89	12.5	14.1	15.8
50	Single vane	1.20	1.86	3.14	4.46	5.69	6.92	8.14	9.5	10.7	11.9
	Double vane	2.70	4.02	6.60	9.21	11.8	14.3	16.7	19.4	21.8	24.2
63	Single vane	2.59	3.77	6.11	8.45	10.8	13.1	15.5	17.8	20.2	22.5
	Double vane	5.85	8.28	13.1	17.9	22.7	27.5	32.3	37.10	41.9	46.7
80	Single vane	4.26	6.18	10.4	14.2	18.0	21.9	25.7	30.0	33.8	37.6
	Double vane	8.70	12.6	21.1	28.8	36.5	44.2	51.8	60.4	68.0	75.6
100	Single vane	8.6	12.2	20.6	28.3	35.9	43.6	51.2	59.7	67.3	75
	Double vane	17.9	25.2	42.0	57.3	72.6	87.9	103	120	135	150

D-□

Rotary Actuators Model Selection

2-3 Effective Torque for Each Equipment

Vane Type/Rotary Table: MSU Series

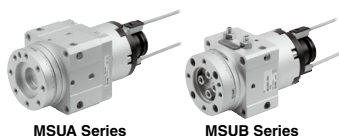

Size	Vane type	Operating pressure (MPa)									
		0.15	0.2	0.3	0.4	0.5	0.6	0.7	0.8	0.9	1.0
1	Single vane	—	0.03	0.06	0.09	0.11	0.14	0.17	—	—	—
	Double vane	—	0.06	0.12	0.18	0.23	0.29	0.35	—	—	—
3	Single vane	0.05	0.09	0.16	0.23	0.31	0.38	0.45	—	—	—
	Double vane	0.11	0.18	0.32	0.46	0.62	0.77	0.91	—	—	—
7	Single vane	0.14	0.21	0.37	0.52	0.69	0.83	0.98	—	—	—
	Double vane	0.29	0.44	0.78	1.10	1.42	1.74	2.04	—	—	—
20	Single vane	0.40	0.58	0.99	1.38	1.78	2.19	2.58	2.99	3.39	3.73
	Double vane	0.86	1.22	2.04	2.82	3.63	4.43	5.22	6.04	6.83	7.49

* Double vane type is MSUB Series only.

Rack & Pinion Type: CRJ Series

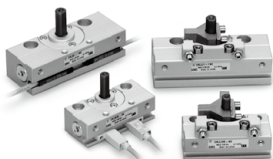

Size	Operating pressure (MPa)						
	0.15	0.2	0.3	0.4	0.5	0.6	0.7
05	0.013	0.017	0.026	0.034	0.042	0.050	0.059
1	0.029	0.038	0.057	0.076	0.095	0.11	0.13

Rack & Pinion Type: CRA1 Series

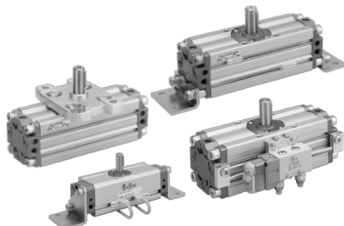

Size	Operating pressure (MPa)									
	0.10	0.20	0.30	0.40	0.50	0.60	0.70	0.80	0.90	1.00
30	0.38	0.76	1.14	1.53	1.91	2.29	2.67	3.05	3.44	3.82
50	1.85	3.71	5.57	7.43	9.27	11.2	13.0	14.9	16.7	18.5
63	3.44	6.88	10.4	13.8	17.2	20.6	24.0	27.5	31.0	34.4
80	6.34	12.7	19.0	25.3	31.7	38.0	44.4	50.7	57.0	63.4
100	14.9	29.7	44.6	59.4	74.3	89.1	104	119	133	149

Rack & Pinion Type: CRQ2 Series

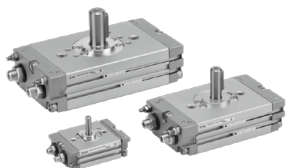

Size	Operating pressure (MPa)										
	0.10	0.15	0.20	0.30	0.40	0.50	0.60	0.70	0.80	0.90	1.00
10	—	0.09	0.12	0.18	0.24	0.30	0.36	0.42	—	—	—
15	—	0.22	0.30	0.45	0.60	0.75	0.90	1.04	—	—	—
20	0.37	0.55	0.73	1.10	1.47	1.84	2.20	2.57	2.93	3.29	3.66
30	0.62	0.94	1.25	1.87	2.49	3.11	3.74	4.37	4.99	5.60	6.24
40	1.06	1.59	2.11	3.18	4.24	5.30	6.36	7.43	8.48	9.54	10.6

Rack & Pinion Type/Rotary Table: MSQ Series

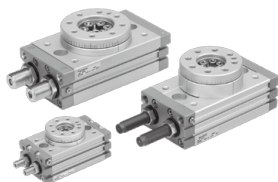

Size	Operating pressure (MPa)									
	0.10	0.20	0.30	0.40	0.50	0.60	0.70	0.80	0.90	1.00
1	0.017	0.035	0.052	0.070	0.087	0.10	0.12	—	—	—
2	0.035	0.071	0.11	0.14	0.18	0.21	0.25	—	—	—
3	0.058	0.12	0.17	0.23	0.29	0.35	0.41	—	—	—
7	0.11	0.22	0.33	0.45	0.56	0.67	0.78	—	—	—
10	0.18	0.36	0.53	0.71	0.89	1.07	1.25	1.42	1.60	1.78
20	0.37	0.73	1.10	1.47	1.84	2.20	2.57	2.93	3.29	3.66
30	0.55	1.09	1.64	2.18	2.73	3.19	3.82	4.37	4.91	5.45
50	0.93	1.85	2.78	3.71	4.64	5.57	6.50	7.43	8.35	9.28
70	1.36	2.72	4.07	5.43	6.79	8.15	9.50	10.9	12.20	13.6
100	2.03	4.05	6.08	8.11	10.1	12.2	14.2	16.2	18.20	20.3
200	3.96	7.92	11.9	15.8	19.8	23.8	27.7	31.7	35.60	39.6

Rotary Actuators Model Selection

③ Confirmation of Rotation Time

Rotation time adjustment range is specified for each product for stable operation. Set the rotation time within the rotation time specified below.

Model	Rotation time adjustment range ^S /90°														
	0.02	0.03	0.05	0.1	0.2	0.3	0.5	1	2	3	4	5	10	20	30
CRB2	Size: 10, 15, 20			Size: 30			Size: 40			Size: 50, 63, 80, 100					
	Size: 10, 15, 20			Size: 30			Size: 40			Size: 50, 63, 80, 100					
CRB1	Size: 10, 15, 20			Size: 30			Size: 40			Size: 50, 63, 80, 100					
CRBU2	Size: 10, 15, 20			Size: 30			Size: 40			Size: 50, 63, 80, 100					
MSU□	Size: 1, 3, 7, 20			Size: 05, 1			Size: 30			Size: 50			Size: 63		
CRA1	Size: 1, 3, 7, 20			Size: 05, 1			Size: 30			Size: 50			Size: 63		
	Size: 1, 3, 7, 20			Size: 05, 1			Size: 30			Size: 50			Size: 63		
	Size: 1, 3, 7, 20			Size: 05, 1			Size: 30			Size: 50			Size: 63		
	Size: 1, 3, 7, 20			Size: 05, 1			Size: 30			Size: 50			Size: 63		
	Size: 1, 3, 7, 20			Size: 05, 1			Size: 30			Size: 50			Size: 63		
CRQ2	Size: 10, 15			Size: 20, 30, 40			Size: 1, 2, 3			Size: 7, 10, 20, 30, 50			Size: 70, 100, 200		
	Size: 10, 15			Size: 20, 30, 40			Size: 1, 2, 3			Size: 7, 10, 20, 30, 50			Size: 70, 100, 200		
MSQ	Size: 10, 20, 30, 50 <small>(with internal shock absorber)</small>			Size: 7, 10, 20, 30, 50 <small>(with internal shock absorber)</small>			Size: 70, 100, 200 <small>(with internal shock absorber)</small>			Size: 70			Size: 100		
	Size: 10, 20, 30, 50 <small>(with internal shock absorber)</small>			Size: 7, 10, 20, 30, 50 <small>(with internal shock absorber)</small>			Size: 70, 100, 200 <small>(with internal shock absorber)</small>			Size: 70			Size: 100		
	Size: 10, 20, 30, 50 <small>(with internal shock absorber)</small>			Size: 7, 10, 20, 30, 50 <small>(with internal shock absorber)</small>			Size: 70, 100, 200 <small>(with internal shock absorber)</small>			Size: 70			Size: 100		
	Size: 10, 20, 30, 50 <small>(with internal shock absorber)</small>			Size: 7, 10, 20, 30, 50 <small>(with internal shock absorber)</small>			Size: 70, 100, 200 <small>(with internal shock absorber)</small>			Size: 70			Size: 100		

*: In case of basic type/with external shock absorber.

If the product is used in a low speed range which is outside the adjustment range, it may cause the stick-slip phenomenon, or the product to stick or stop.

* For the CRA1 series air-hydro type, combine with an air-hydro unit (CC series) and set the rotation time.

CRB□2
CRB1
MSU
CRJ
CRA1
CRQ2
MSQ
MSZ
CRQ2X
MSQX
MRQ

D-□

Rotary Actuators Model Selection

④ Calculation of Kinetic Energy

Kinetic energy is generated when the load rotates. Kinetic energy applies on the product at the operating end as inertial force, and may cause the product to damage. In order to avoid this, the value of allowable kinetic energy is determined for each product. Find the kinetic energy of the load, and verify that it is within the allowable range for the product in use.

Kinetic Energy

Use the following formula to calculate the kinetic energy of the load.

$$E = \frac{1}{2} \cdot I \cdot \omega^2$$

E: Kinetic energy (J)

I: Moment of inertia (kg·m²)

ω: Angle speed (rad/s)

* For the MSU Series, add the values shown in the table below to the moment of inertia of the load when calculating.

Model	Additional value of moment of inertia; I ₀
MSU□ 1	2.5 x 10 ⁻⁶
MSU□ 3	6.2 x 10 ⁻⁶
MSU□ 7	1.6 x 10 ⁻⁵
MSU□20	2.8 x 10 ⁻⁵

Kinetic energy formula for MSU series

$$E = \frac{1}{2} (I + I_0) \omega^2$$

Angle Speed

$$\omega = \frac{2\theta}{t}$$

ω: Angle speed (rad/s)

θ: Rotation angle (rad)

t: Rotation time (s)

However, for the air-hydro type, when the rotation time for 90° becomes longer than 2 seconds, use the following formula.

$$\omega = \frac{\theta}{t}$$

⇒P.35 Allowable kinetic energy and rotation time adjustment range

⇒P.36 to 38 Moment of inertia and rotation time

To find the rotation time when kinetic energy is within the allowable range for the product, use the following formula.

When the rotation angle is $\omega = \frac{2\theta}{t}$

$$t \geq \sqrt{\frac{2 \cdot I \cdot \theta^2}{E}}$$

t: Rotation time (s)

I: Moment of inertia (kg·m²)

θ: Rotation angle (rad)

E: Kinetic energy (J)

When the rotation angle is $\omega = \frac{\theta}{t}$

$$t \geq \sqrt{\frac{I \cdot \theta^2}{2E}}$$

Rotary Actuators Model Selection

4-1 Allowable Kinetic Energy and Rotation Time Adjustment Range

Table (1a) Allowable Kinetic Energy and Rotation Time Adjustment Range of the Single Vane

Model	Allowable kinetic energy (J)		Adjustable range of rotation time safe in operation (°/90°)
	Without rubber bumper	With rubber bumper	
CRB2 □ 10	0.00015	—	0.03 to 0.3
CRB2 □ 15	0.00025	0.001	
CRB2 □ 20	0.00040	0.003	
CRB2 □ 30	0.015	0.020	
CRB2 □ 40	0.030	0.040	0.07 to 0.5
CRB1 □ 50	—	0.082	0.1 to 1
CRB1 □ 63	—	0.120	
CRB1 □ 80	—	0.398	
CRB1 □ 100	—	0.600	
CRB1 □ 100	—	0.600	
CRBU2 □ 10	0.00015	—	0.03 to 0.3
CRBU2 □ 15	0.00025	0.001	
CRBU2 □ 20	0.0004	0.003	
CRBU2 □ 30	0.015	0.02	
CRBU2 □ 40	0.030	0.040	0.07 to 0.5
MSUA 1	0.0065	—	0.07 to 0.3
MSUA 3	0.017	—	
MSUA 7	0.042	—	
MSUA 20	0.073	—	
MSUB 1	0.005	—	
MSUB 3	0.013	—	
MSUB 7	0.032	—	
MSUB 20	0.056	—	

Table (1b) Allowable Kinetic Energy and Rotation Time Adjustment Range of the Double Vane

Model	Allowable kinetic energy (J)		Adjustable range of rotation time safe in operation (°/90°)
	Without rubber bumper	With rubber bumper	
CRB2 □ 10	0.0003	—	0.03 to 0.3
CRB2 □ 15	0.0005	0.0012	
CRB2 □ 20	0.0007	0.0033	
CRB2 □ 30	0.015	0.020	
CRB2 □ 40	0.030	0.040	0.07 to 0.5
CRB1 □ 50	—	0.112	0.1 to 1
CRB1 □ 63	—	0.160	
CRB1 □ 80	—	0.540	
CRB1 □ 100	—	0.811	
CRB1 □ 100	—	0.811	
CRBU2 □ 10	0.0003	—	0.03 to 0.3
CRBU2 □ 15	0.0005	0.0012	
CRBU2 □ 20	0.0007	0.0033	
CRBU2 □ 30	0.015	0.020	
CRBU2 □ 40	0.030	0.040	0.07 to 0.5
MSUB 1	0.005	—	0.07 to 0.3
MSUB 3	0.013	—	
MSUB 7	0.032	—	
MSUB 20	0.056	—	

Note) Not using rubber bumper means that the rotary actuator is stopped in the middle of its rotation through the use of an external stopper.

Note) Using a rubber bumper means that the rotary actuator is stopped at the respective rotation ends by using an internal stopper.

Calculation Example

Load form: Round rod
 Length of a₁ part: 0.12 m Rotation angle : 90°
 Length of a₂ part: 0.04 m Rotation time : 0.9 °/90°
 Mass of a₁ part (= m₁): 0.09 kg
 Mass of a₂ part (= m₂): 0.03 kg

$$I = m_1 \frac{a_1^2}{3} + m_2 \frac{a_2^2}{3}$$

(Step 1) Find the angle speed ω.

$$\omega = \frac{2\theta}{t} = \frac{2}{0.9} \left(\frac{\pi}{2} \right) = 3.489 \text{ rad/s}$$

(Step 2) Find the moment of inertia I.

$$I = \frac{m_1 a_1^2}{3} + \frac{m_2 a_2^2}{3} = \frac{0.09 \times 0.12^2}{3} + \frac{0.03 \times 0.04^2}{3} = 4.48 \times 10^{-4} \text{ kg}\cdot\text{m}^2$$

(Step 3) Find the kinetic energy E.

$$E = \frac{1}{2} \cdot I \cdot \omega^2 = \frac{1}{2} \times 4.48 \times 10^{-4} \times 3.489^2 = 0.00273 \text{ J}$$

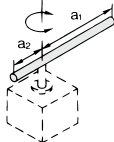

Table (2) Allowable Kinetic Energy and Rotation Time Adjustment Range

Model	Allowable kinetic energy (J)		Cushion angle	Adjustable range of rotation time safe in operation (°/90°)
	Without rubber bumper	With rubber bumper		
CRJ □ 05	0.00025	—	—	0.1 to 0.5
	0.001-1	—		
	0.00040	—		
CRJ □ 1	0.002-1	—	—	—
	—	—		
	—	—		
CRJ □ 30	0.010	0.120 ^{*2}	35°	0.2 to 1
CRA1 □ 50	0.050	0.980 ^{*2}		0.2 to 2
CRA1 □ 63	0.120	1.500 ^{*2}		0.2 to 3
CRA1 □ 80	0.160	2.000 ^{*2}		0.2 to 4
CRA1 □ 100	0.540	2.900 ^{*2}		0.2 to 5
CRQ2 □ 10	0.00025	—	40°	0.2 to 0.7
CRQ2 □ 15	0.00039	—		—
CRQ2 □ 20	0.025	0.120 ^{*2}		—
CRQ2 □ 30	0.048	0.250 ^{*2}		—
CRQ2 □ 40	0.081	0.400 ^{*2}		—
MSQ □ 1	0.001	—	—	0.2 to 0.7
MSQ □ 2	0.0015	—		
MSQ □ 3	0.002	—		
MSQ □ 7	0.006	—		
MSQ □ 7	0.006	—		
MSQ □ 10	0.007	0.039 ^{*3}	52°	0.2 to 0.7 ^{*3}
		0.161 ^{*4}	7.1°	
		0.231 ^{*5}	8.6°	
		0.116 ^{*5}	43°	
		0.574 ^{*5}	6.9°	
MSQ □ 20	0.025	0.060 ^{*5}	8.0°	0.2 to 1
		0.116 ^{*5}	40°	0.2 to 0.7 ^{*3}
		0.805 ^{*4}	6.2°	
MSQ □ 30	0.048	0.120 ^{*5}	7.3°	0.2 to 1
		0.294 ^{*3}	60°	0.2 to 0.7 ^{*3}
		1.310 ^{*4}	9.6°	
MSQ □ 50	0.081	1.820 ^{*5}	10.5°	0.2 to 1
		1.100 ^{*3}	71°	0.2 to 1.5
		1.600 ^{*3}	62°	0.2 to 2
MSQB 70	0.24	2.900 ^{*3}	82°	0.2 to 2.5
MSQB 100	0.32	—	—	0.2 to 1 ^{*3}
MSQB 200	0.56	—	—	—

*1 Represents external stopper.

*2 When the cushion needle with air cushion is adjusted optimally.

*3 Represents internal shock absorber.

*4 Represents external and low energy type shock absorber.

*5 Represents external and high energy type shock absorber.

Calculation Example

If the model to be used has been determined, obtain the threshold rotation time in which the rotary actuator can be used in accordance with the allowable kinetic energy of that model.

Model used : CRA1□100 (Without bumper)

Allowable kinetic energy : 0.05 J (Refer to Table (2))

Load form : Refer to the figure below

Rotation angle : 90°

$$I = m_1 \frac{a_1^2}{3} + m_2 a_2^2 + m_3 \frac{2r^2}{5}$$

(Step 1) Find the moment of inertia.

$$I = \frac{m_1 a_1^2}{3} + m_2 a_2^2 + \frac{m_3 2r^2}{5} = \frac{0.1 \times 0.12^2}{3} + 0.18 \times 0.15^2 + \frac{0.18 \times 2 \times 0.03^2}{5} = 4.6 \times 10^{-3} \text{ kg}\cdot\text{m}^2$$

(Step 2) Find the rotating time.

$$t \geq \sqrt{\frac{2 \cdot I \cdot \theta^2}{E}} = \sqrt{\frac{2 \times 4.6 \times 10^{-3} \times (\pi/2)^2}{0.05}} = 0.67 \text{ s}$$

It is therefore evident that there will be no problem if it is used with a rotation time of less than 0.67s. However, according to table 2, the maximum value of rotation time for stable operation is 2s. Thus, the rotation time should be within the range of 0.67 ≤ t ≤ 2.

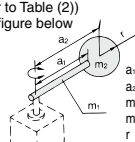

a₁ : 0.12 m
 a₂ : 0.15 m
 m : 0.1 kg
 m₃ : 0.18 kg
 r : 0.03 m

Rotary Actuators Model Selection

4-2 Moment of Inertia and Rotation Time

How to read the graph

Example 1) When there are constraints for the moment of inertia of load and rotation time. From "Graph (5)", to operate at the load moment of inertia $1 \times 10^{-4} \text{ kg}\cdot\text{m}^2$ and at the rotation time setting of $0.3 \text{ }^\circ/\text{s}$, the models will be CRB□30-□S and CRB□30-□D.

Example 2) When there are constraints for the moment of inertia of load, but not for rotation time. From "Graph (6)", to operate at the load moment of inertia $1 \times 10^{-2} \text{ kg}\cdot\text{m}^2$:
 CRB1□50-□S will be 0.8 to $1 \text{ }^\circ/\text{s}$
 CRB1□80-□S will be 0.35 to $1 \text{ }^\circ/\text{s}$
 CRB1□100-□S will be 0.29 to $1 \text{ }^\circ/\text{s}$

[Remarks] As for the rotation times in "Graphs (5) to (15)", the lines in the graph indicate the adjustable speed ranges. If the speed is adjusted towards the low-speed end beyond the range of the line, it could cause the actuator to stick, or, in the case of the vane type, it could stop its operation.

<Vane type: CRB2/CRBU2/CRB1/MSU Series>

Graph (5) CRB2□, CRBU2□/Size: 10 to 40

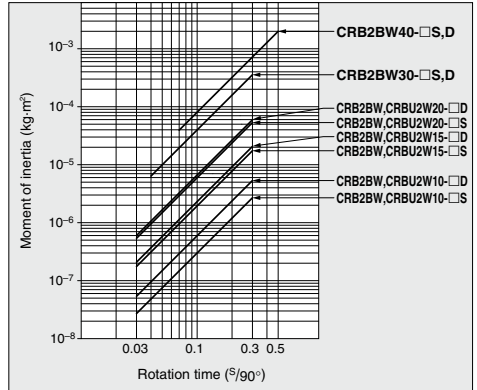

Graph (6) CRB1□/Size: 50 to 100

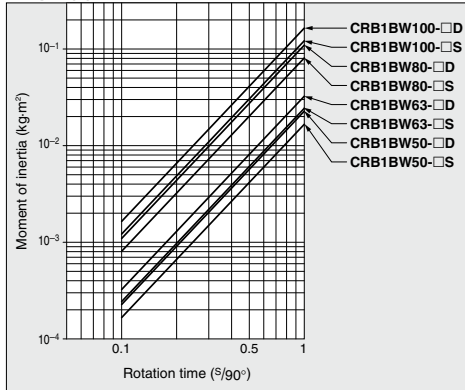

Graph (7) MSU□/Size: 1 to 20

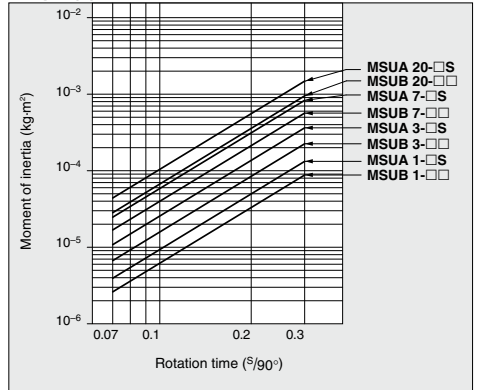

Rotary Actuators Model Selection

<Rack & pinion type: CRJ/CRA1 Series>

Graph (8) CRJ/Size: 05, 1

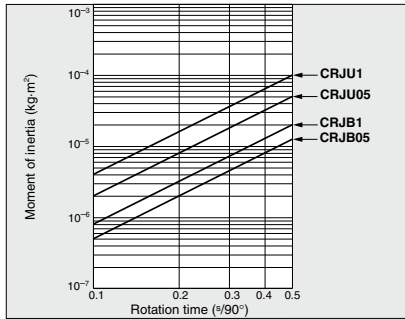

Graph (9) CRA1/Size: 30 to 100 (Without cushion)

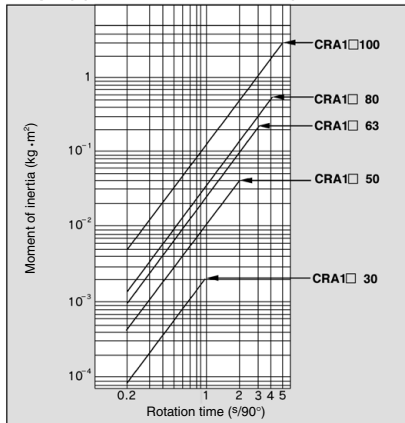

Graph (10) CRA1/Size: 30 to 100 (With cushion)

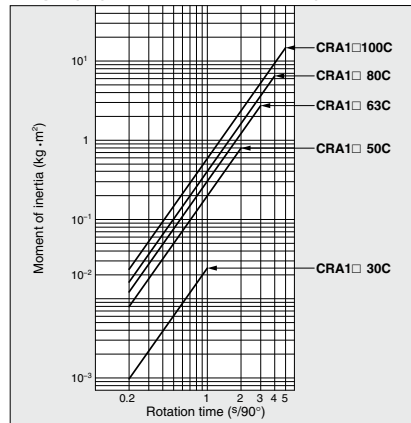

<Rack & pinion type: CRQ2/MSQ Series>

Graph (11) CRQ2/Size: 10 to 40 (Without cushion)

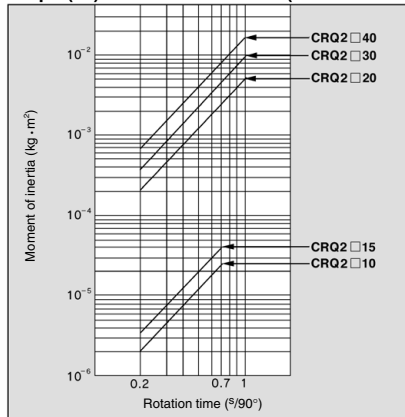

Graph (12) CRQ2/Size: 20 to 40 (With cushion)

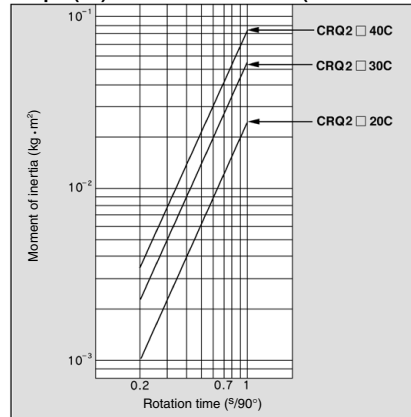

CRB□2

CRB1

MSU

CRJ

CRA1

CRQ2

MSQ

MSZ

CRQ2X
MSQX

MRQ

D-□

Rotary Actuators Model Selection

4-2 Moment of Inertia and Rotation Time

Graph (13) MSQ□/Size: 10 to 200 (Adjust bolt type)

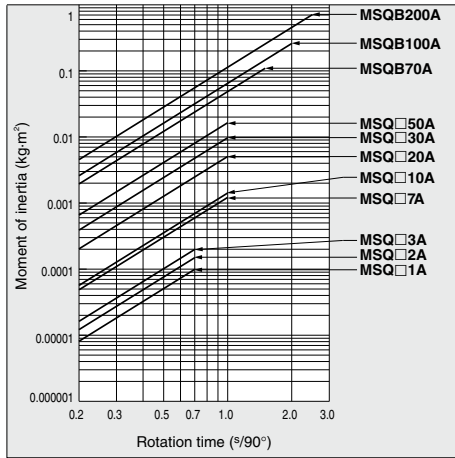

Graph (14) MSQ□/Size: 10 to 200 (Internal absorber type)

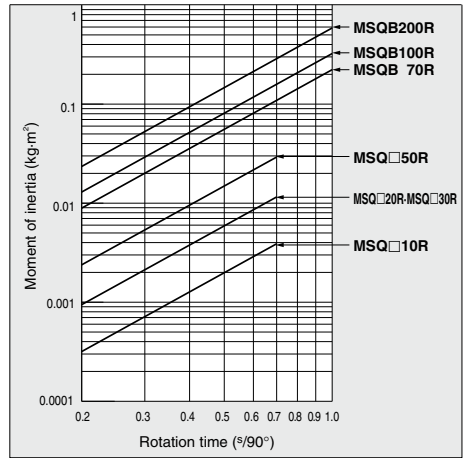

Graph (15) MSQ□/Size: 10 to 50 (External absorber type)

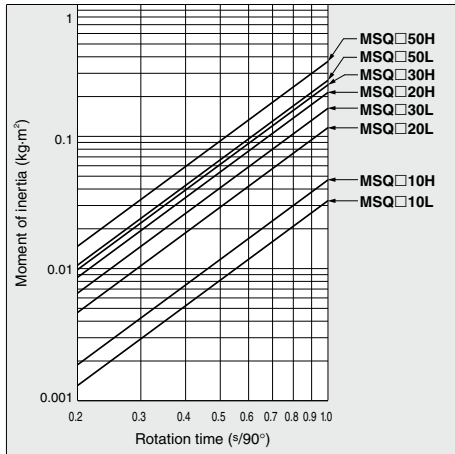

Rotary Actuators Model Selection

Confirmation of Allowable Load

Provided that a dynamic load is not generated, a load in the axial direction can be applied up to the value that is indicated in the table below. However, applications in which the load is applied directly to the shaft should be avoided as much as possible.

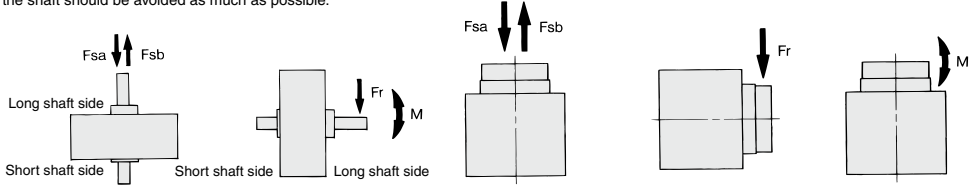

Vane Type

Vane Type (Single, Double)

Series	Model	Load direction			
		Fsa (N)	Fsb (N)	Fr (N)	M (N-m)
CRB	CRB2 □ 10	9.8	9.8	14.7	0.13
	CRB2 □ 15	9.8	9.8	14.7	0.17
	CRB2 □ 20	19.6	19.6	24.5	0.33
	CRB2 □ 30	24.5	24.5	29.4	0.42
	CRB2 □ 40	40	40	60	1.02
	CRB1 □ 50	196	196	245	8.09
	CRB1 □ 63	340	340	390	14.04
CRBU2	CRBU2 □ 80	490	490	490	20.09
	CRBU2 □ 100	539	539	588	30.28
	CRBU2 □ 10	9.8	9.8	14.7	0.13
	CRBU2 □ 15	9.8	9.8	14.7	0.17
	CRBU2 □ 20	19.6	19.6	24.5	0.33
	CRBU2 □ 30	24.5	24.5	29.4	0.42
	CRBU2 □ 40	40	40	60	1.02

Vane Type (Single, Double)

Series	Model	Load direction			
		Fsa (N)	Fsb (N)	Fr (N)	M (N-m)
MSUA	MSUA 1	15	15	20	0.3
	MSUA 3	30	30	40	0.7
	MSUA 7	60	60	50	0.9
	MSUA20	80	80	60	2.9
MSUB	MSUB 1	10	15	20	0.3
	MSUB 3	15	30	40	0.7
	MSUB 7	30	60	50	0.9
	MSUB20	40	80	60	2.9

Provided that a dynamic load is not generated, a load that is within the allowable radial/thrust load can be applied. However, applications in which the load is applied directly to the shaft should be avoided as much as possible. The methods such as those described below are recommended to prevent the load from being applied directly to the shaft in order to ensure a proper operating condition.

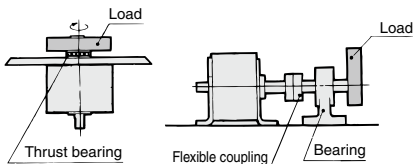

Rack & Pinion Type

Rack & Pinion Type (Single rack)

Series	Model	Load direction			
		Fsa (N)	Fsb (N)	Fr (N)	M (N-m)
CRJ	CRJ □ 05	20	20	25	0.26
	CRJ □ 1	25	25	30	0.32

Rack & Pinion Type (Single rack)

Series	Model	Load direction			
		Fsa (N)	Fsb (N)	Fr (N)	M (N-m)
CRA1	CRA1 □ 30	29.4	29.4	29.4	0.44
	CRA1 □ 50	490	196	196	3.63
	CRA1 □ 63	588	196	294	6.17
	CRA1 □ 80	882	196	392	9.80
	CRA1 □ 100	980	196	588	11.17

Rack & Pinion Type (Double rack)

Series	Model	Load direction			
		Fsa (N)	Fsb (N)	Fr (N)	M (N-m)
CRQ2	CRQ2B □ 10	15.7	7.8	14.7	0.21
	CRQ2B □ 15	19.6	9.8	19.6	0.32
	CRQ2B □ 20	49	29.4	49	0.96
	CRQ2B □ 30	98	49	78	1.60
	CRQ2B □ 40	108	59	98	2.01

Rack & Pinion Type (Double rack)

Series	Model	Load direction			
		Fsa (N)	Fsb (N)	Fr (N)	M (N-m)
MSQA	MSQA 1 □	41	41	31	0.84
	MSQA 2 □	45	45	32	1.2
	MSQA 3 □	48	48	33	1.6
	MSQA 7 □	71	71	54	2.2
	MSQA 10 □	107	74	86	2.9
	MSQA 20 □	197	137	166	4.8
	MSQA 30 □	398	197	233	6.4
	MSQA 50 □	517	296	378	12.0
MSQB	MSQB 1 □	41	41	31	0.56
	MSQB 2 □	45	45	32	0.82
	MSQB 3 □	48	48	33	1.1
	MSQB 7 □	71	71	54	1.5
	MSQB 10 □	78	74	78	2.4
	MSQB 20 □	137	137	147	4.0
	MSQB 30 □	363	197	196	5.3
	MSQB 50 □	451	296	314	9.7
	MSQB 70 □	476	296	333	12.0
	MSQB100 □	708	493	390	18.0
	MSQB200 □	1009	740	543	25.0

CRB □ 2

CRB1

MSU

CRJ

CRA1

CRQ2

MSQ

MSZ

CRQ2X

MSQX

MRQ

D-□

Rotary Actuators Model Selection

⑥ Calculation of Air Consumption and Required Air Flow Capacity

Air consumption is the volume of air which is expended by the rotary actuator's reciprocal operation inside the actuator and in the piping between the actuator and the switching valve, etc. This is necessary for selection of a compressor and for calculation of its running cost. Required air volume is the air volume necessary to make a rotary actuator operate at a required speed. It requires calculation when selecting the upstream piping diameter from the switching valve and air line equipment.

* To facilitate your calculation, Tables (1) to (5) provide the air consumption volume (Q_{CR}) that is required each time an individual rotary actuator makes a reciprocal movement.

1. Air consumption volume

Formula

Regarding QCR: With vane type sizes 10 to 40, use formula (1) because the internal volume varies when ports A and B are pressurized. For vane type sizes 50 to 100, as well as for the rack and pinion type, use formula (2).

$$Q_{CR} = (V_A + V_B) \times \left(\frac{P + 0.1}{0.1} \right) \times 10^{-3} \dots\dots\dots (1)$$

$$Q_{CR} = 2 \times V_A \times \left(\frac{P + 0.1}{0.1} \right) \times 10^{-3} \dots\dots\dots (2)$$

$$Q_{CP} = 2 \times a \times L \times \left(\frac{P}{0.1} \right) \times 10^{-6} \dots\dots\dots (3)$$

$$Q_C = Q_{CR} + Q_{CP} \dots\dots\dots (4)$$

Q_{CR} = Amount of air consumption of rotary actuator [L/(ANR)]

Q_{CP} = Amount of air consumption of tube or piping [L/(ANR)]

V_A = Inner volume of the rotary actuator (when pressurized from A port) [cm³]

V_B = Inner volume of the rotary actuator (when pressurized from B port) [cm³]

P = Operating pressure [MPa]

L = Length of piping [mm]

a = Inner sectional area of piping [mm²]

Q_C = Amount of air consumption required for one cycle of the rotary actuator [L/(ANR)]

To select a compressor, it is important to select one that has plenty of margin to accommodate the total air volume that is consumed by the pneumatic actuators that are located downstream. The total air consumption volume is affected by the leakage in the tube, the consumption in the drain valves and pilot valves, as well as by the reduction in air volume due to reduced temperature.

Formula

$$Q_{C2} = Q_C \times n \times \text{No. of actuators} \times \text{Space rate} \dots\dots\dots (5)$$

Q_C = Amount of air from a compressor [L/min (ANR)]

n = Actuator reciprocations per minute

Safety factor: from 1.5

2. Required air flow capacity

Formula

Q_r: Make use of (6)(7) formula for vane type, and (7) for rack and pinion type.

$$Q_r = \left\{ V_B \times \left(\frac{P + 0.1}{0.1} \right) \times 10^{-3} + a \times L \times \left(\frac{P}{0.1} \right) \times 10^{-6} \right\} \times \frac{60}{t} \dots\dots\dots (6)$$

$$Q_r = \left\{ V_A \times \left(\frac{P + 0.1}{0.1} \right) \times 10^{-3} + a \times L \times \left(\frac{P}{0.1} \right) \times 10^{-6} \right\} \times \frac{60}{t} \dots\dots\dots (7)$$

Q_r = Consumed air volume for rotary actuator [L/min(ANR)]

V_A = Inner volume of the rotary actuator (when pressurized from A port) [cm³]

V_B = Inner volume of the rotary actuator (when pressurized from B port) [cm³]

P = Operating pressure [MPa]

L = Length of piping [mm]

a = Inner sectional area of piping [mm²]

t = Total time for rotation [S]

Internal Cross Section of Tubing and Steel Piping

Nominal	O.D. (mm)	I.D. (mm)	Internal cross section a (mm ²)
T□ 0425	4	2.5	4.9
T□ 0604	6	4	12.6
TU 0805	8	5	19.6
T□ 0806	8	6	28.3
1/8B	—	6.5	33.2
T□ 1075	10	7.5	44.2
TU 1208	12	8	50.3
T□ 1209	12	9	63.6
1/4B	—	9.2	66.5
TS 1612	16	12	113
3/8B	—	12.7	127
T□ 1613	16	13	133
1/2B	—	16.1	204
3/4B	—	21.6	366
1B	—	27.6	598

⇒P.41 and 42 Inner volume and air consumption

⇒P.43 and 44 Air consumption calculation graph

Rotary Actuators Model Selection

6-1 Inner Volume and Air Consumption

Table (1) Vane Type: CRB2/CRBU2/CRB1 Series

(L(ANR))

Vane	Size	Rotation (degree)	Inner volume (cm ³)		Operating pressure (MPa)												
			Press. V _a port	Press. V _b port	0.15	0.2	0.3	0.4	0.5	0.6	0.7	0.8	0.9	1.0			
Single vane	10	90	0.6	1.0	—	0.005	0.006	0.008	0.010	0.011	0.013	—	—	—	—	—	—
		180	1.2	1.2	—	0.007	0.010	0.012	0.014	0.017	0.019	—	—	—	—	—	—
		270	1.5	1.5	—	0.009	0.012	0.015	0.018	0.021	0.024	—	—	—	—	—	—
	15	90	1.0	1.5	0.006	0.008	0.010	0.013	0.015	0.018	0.020	—	—	—	—	—	—
		180	2.9	2.9	0.015	0.017	0.023	0.029	0.035	0.041	0.046	—	—	—	—	—	—
		270	3.7	3.7	0.019	0.022	0.030	0.037	0.044	0.052	0.059	—	—	—	—	—	—
	20	90	3.6	4.8	0.021	0.025	0.034	0.042	0.050	0.059	0.067	—	—	—	—	—	—
		180	6.1	6.1	0.031	0.037	0.049	0.061	0.073	0.085	0.098	—	—	—	—	—	—
		270	7.9	7.9	0.040	0.047	0.063	0.079	0.095	0.111	0.126	—	—	—	—	—	—
	30	90	8.5	11.3	0.050	0.059	0.079	0.099	0.119	0.139	0.158	0.178	0.198	0.218	—	—	—
		180	15	15	0.075	0.090	0.120	0.150	0.180	0.210	0.240	0.270	0.300	0.330	—	—	—
		270	20.2	20.2	0.101	0.121	0.162	0.202	0.242	0.283	0.323	0.364	0.404	0.444	—	—	—
	40	90	21	25	0.115	0.138	0.184	0.230	0.276	0.322	0.368	0.414	0.460	0.506	—	—	—
		180	31.5	31.5	0.158	0.189	0.252	0.315	0.378	0.441	0.504	0.567	0.630	0.693	—	—	—
		270	41	41	0.205	0.246	0.328	0.410	0.492	0.574	0.656	0.738	0.820	0.902	—	—	—
	50	90	30	30	0.150	0.180	0.240	0.300	0.360	0.420	0.480	0.540	0.600	0.660	—	—	—
		100	32	32	0.160	0.192	0.256	0.320	0.384	0.448	0.512	0.576	0.640	0.704	—	—	—
		180	49	49	0.245	0.294	0.392	0.490	0.588	0.686	0.784	0.882	0.980	1.078	—	—	—
	63	90	51	51	0.255	0.306	0.408	0.510	0.612	0.714	0.816	0.918	1.020	1.122	—	—	—
		180	66	66	0.330	0.396	0.528	0.660	0.792	0.924	1.056	1.188	1.320	1.452	—	—	—
		270	68	68	0.340	0.408	0.544	0.680	0.816	0.952	1.088	1.224	1.360	1.496	—	—	—
	80	90	70	70	0.350	0.420	0.560	0.700	0.840	0.980	1.120	1.260	1.400	1.540	—	—	—
		100	73	73	0.365	0.438	0.584	0.730	0.876	1.022	1.168	1.314	1.460	1.606	—	—	—
		180	94	94	0.470	0.564	0.752	0.940	1.128	1.316	1.504	1.692	1.880	2.068	—	—	—
	100	90	97	97	0.485	0.582	0.776	0.970	1.164	1.358	1.552	1.746	1.940	2.134	—	—	—
		180	118	118	0.590	0.708	0.944	1.180	1.416	1.652	1.888	2.124	2.360	2.596	—	—	—
		270	121	121	0.605	0.726	0.968	1.210	1.452	1.694	1.936	2.178	2.420	2.662	—	—	—
	100	90	88	88	0.440	0.528	0.704	0.880	1.056	1.232	1.408	1.584	1.760	1.936	—	—	—
		100	93	93	0.465	0.558	0.744	0.930	1.116	1.302	1.488	1.674	1.860	2.046	—	—	—
		180	138	138	0.690	0.828	1.104	1.380	1.656	1.932	2.208	2.484	2.760	3.036	—	—	—
	100	90	143	143	0.715	0.858	1.144	1.430	1.716	2.002	2.288	2.574	2.860	3.146	—	—	—
		180	188	188	0.940	1.128	1.504	1.880	2.256	2.632	3.008	3.384	3.760	4.136	—	—	—
		270	193	193	0.965	1.158	1.544	1.930	2.316	2.702	3.088	3.474	3.860	4.246	—	—	—
	100	90	186	186	0.930	1.116	1.488	1.860	2.232	2.604	2.976	3.348	3.720	4.092	—	—	—
		100	197	197	0.985	1.182	1.576	1.970	2.364	2.756	3.152	3.546	3.940	4.334	—	—	—
		180	281	281	1.405	1.686	2.248	2.810	3.372	3.934	4.496	5.058	5.620	6.182	—	—	—
	100	90	292	292	1.460	1.752	2.336	2.920	3.504	4.088	4.672	5.256	5.840	6.424	—	—	—
		180	376	376	1.880	2.256	3.008	3.760	4.512	5.264	6.016	6.768	7.520	8.272	—	—	—
		270	387	387	1.935	2.322	3.096	3.870	4.644	5.416	6.192	6.966	7.740	8.514	—	—	—
	Double vane	10	90	1.0	1.0	—	0.006	0.008	0.010	0.012	0.014	0.016	—	—	—	—	—
			100	1.1	1.1	—	0.007	0.009	0.011	0.013	0.015	0.018	—	—	—	—	—
		15	90	2.6	2.6	0.013	0.016	0.021	0.026	0.031	0.036	0.042	—	—	—	—	—
			100	2.7	2.7	0.014	0.016	0.022	0.027	0.032	0.038	0.043	—	—	—	—	—
		20	90	5.6	5.6	0.028	0.034	0.045	0.056	0.067	0.078	0.090	—	—	—	—	—
			100	5.7	5.7	0.029	0.034	0.046	0.057	0.068	0.080	0.091	—	—	—	—	—
		30	90	14.4	14.4	0.072	0.086	0.115	0.144	0.173	0.202	0.230	0.259	0.288	0.317	—	—
			100	14.5	14.5	0.073	0.087	0.116	0.145	0.174	0.203	0.232	0.261	0.290	0.319	—	—
		40	90	33	33	0.165	0.198	0.264	0.330	0.396	0.462	0.528	0.594	0.660	0.726	—	—
			100	34	34	0.170	0.204	0.272	0.340	0.408	0.476	0.544	0.612	0.680	0.748	—	—
		50	90	48	48	0.240	0.288	0.384	0.480	0.576	0.672	0.768	0.864	0.960	1.056	—	—
			100	52	52	0.260	0.312	0.416	0.520	0.624	0.728	0.832	0.936	1.040	1.144	—	—
		63	90	98	98	0.490	0.588	0.784	0.980	1.176	1.372	1.568	1.764	1.960	2.156	—	—
			100	104	104	0.520	0.624	0.832	1.040	1.248	1.456	1.664	1.872	2.080	2.288	—	—
		80	90	136	136	0.680	0.816	1.088	1.360	1.632	1.904	2.176	2.448	2.720	2.992	—	—
100			146	146	0.730	0.876	1.168	1.460	1.752	2.044	2.336	2.628	2.920	3.212	—	—	
100		90	272	272	1.360	1.632	2.176	2.720	3.264	3.808	4.352	4.896	5.440	5.984	—	—	
		100	294	294	1.470	1.764	2.352	2.940	3.528	4.116	4.704	5.292	5.880	6.468	—	—	

CRB2
CRB1
MSU
CRJ
CRA1
CRQ2
MSQ
MSZ
CRQ2X
MSQX
MRQ

Table (2) Vane Type Rotary Table: MSU Series

(L(ANR))

Vane	Size	Rotation (degree)	Inner volume (cm ³)		Operating pressure (MPa)											
			Press. V _a port	Press. V _b port	0.15	0.2	0.3	0.4	0.5	0.6	0.7	0.8	0.9	1.0		
Single vane	1	90	0.8	1.3	—	0.006	0.008	0.011	0.013	0.015	0.017	—	—	—	—	—
		180	1.3	1.3	—	0.008	0.010	0.013	0.016	0.018	0.021	—	—	—	—	—
	3	90	1.9	3.1	0.013	0.015	0.020	0.025	0.030	0.035	0.040	—	—	—	—	—
		180	3.1	3.1	0.016	0.019	0.025	0.031	0.037	0.043	0.050	—	—	—	—	—
	7	90	4.0	6.6	0.027	0.032	0.042	0.053	0.064	0.074	0.085	—	—	—	—	—
		180	6.6	6.6	0.033	0.040	0.053	0.066	0.079	0.092	0.106	—	—	—	—	—
20	90	10.1	16.8	0.067	0.081	0.108	0.135	0.161	0.188	0.215	0.242	0.269	0.296	—	—	
	180	16.8	16.8	0.084	0.101	0.134	0.168	0.202	0.235	0.269	0.302	0.336	0.370	—	—	
Double vane (MSUB only)	1	90	1.1	1.1	—	0.007	0.009	0.011	0.013	0.015	0.018	—	—	—	—	—
		3	90	2.7	2.7	0.014	0.016	0.022	0.027	0.032	0.038	0.043	—	—	—	—
	7	90	5.7	5.7	0.029	0.034	0.046	0.057	0.068	0.080	0.091	—	—	—	—	—
		20	90	14.5	14.5	0.073	0.087	0.116	0.145	0.174	0.203	0.232	0.261	0.290	0.319	—

D-□

Rotary Actuators Model Selection

⑥-1 Inner Volume and Air Consumption

Table (3) Rack & Pinion Type: CRJ Series

(L(ANR))

Size	Rotation (degree)	Volume V _A (cm ³)	Operating pressure (MPa)						
			0.15	0.2	0.3	0.4	0.5	0.6	0.7
05	90	0.15	0.00074	0.00089	0.0012	0.0015	0.0018	0.0021	0.0024
	180	0.31	0.0015	0.0018	0.0025	0.0031	0.0037	0.0043	0.0049
1	90	0.33	0.0016	0.0020	0.0026	0.0033	0.0039	0.0046	0.0052
	180	0.66	0.0033	0.0039	0.0052	0.0065	0.0078	0.0091	0.010

Table (4) Rack & Pinion Type: CRA1 Series

(L(ANR))

Size	Rotation (degree)	Volume V _A (cm ³)	Operating pressure (MPa)									
			0.1	0.2	0.3	0.4	0.5	0.6	0.7	0.8	0.9	1.0
30	90	7.4	0.030	0.044	0.059	0.074	0.089	0.104	0.118	0.133	0.148	0.163
	180	14	0.056	0.084	0.112	0.140	0.168	0.196	0.224	0.252	0.280	0.308
50	90	32	0.128	0.192	0.256	0.320	0.384	0.448	0.512	0.576	0.640	0.704
	100	36	0.144	0.216	0.288	0.360	0.432	0.504	0.576	0.648	0.720	0.792
	180	65	0.260	0.390	0.520	0.650	0.780	0.910	1.040	1.170	1.300	1.430
	190	68	0.272	0.408	0.544	0.680	0.816	0.952	1.088	1.224	1.360	1.496
63	90	60	0.240	0.360	0.480	0.600	0.720	0.840	0.960	1.080	1.200	1.320
	100	67	0.268	0.402	0.536	0.670	0.804	0.938	1.072	1.206	1.340	1.474
	180	120	0.480	0.720	0.960	1.200	1.440	1.680	1.920	2.160	2.400	2.640
	190	127	0.508	0.762	1.016	1.270	1.524	1.778	2.032	2.286	2.540	2.794
80	90	111	0.444	0.666	0.888	1.110	1.332	1.554	1.776	1.998	2.220	2.442
	100	123	0.492	0.738	0.984	1.230	1.476	1.722	1.968	2.214	2.460	2.706
	180	221	0.884	1.326	1.768	2.210	2.652	3.094	3.536	3.978	4.420	4.862
	190	233	0.932	1.398	1.864	2.330	2.796	3.262	3.728	4.194	4.660	5.126
100	90	259	1.036	1.554	2.072	2.590	3.108	3.626	4.144	4.662	5.180	5.698
	100	288	1.152	1.728	2.304	2.880	3.456	4.032	4.608	5.184	5.760	6.336
	180	518	2.072	3.108	4.144	5.180	6.216	7.252	8.288	9.324	10.36	11.396
	190	547	2.188	3.282	4.376	5.470	6.564	7.658	8.752	9.846	10.940	12.034

Table (5) Rack & Pinion Type: CRQ2 Series

(L(ANR))

Size	Rotation (degree)	Volume V _A (cm ³)	Operating pressure (MPa)										
			0.1	0.15	0.2	0.3	0.4	0.5	0.6	0.7	0.8	0.9	1.0
10	90	1.2	—	0.006	0.007	0.009	0.012	0.014	0.016	0.018	—	—	—
	180	2.2	—	0.011	0.013	0.018	0.022	0.026	0.031	0.035	—	—	—
	360	4.3	—	0.021	0.026	0.034	0.043	0.051	0.060	0.068	—	—	—
15	90	2.9	—	0.015	0.017	0.023	0.029	0.035	0.041	0.046	—	—	—
	180	5.5	—	0.028	0.033	0.044	0.055	0.066	0.077	0.088	—	—	—
	360	10.7	—	0.023	0.064	0.086	0.107	0.129	0.193	0.172	—	—	—
20	90	7.1	0.028	0.036	0.043	0.057	0.071	0.085	0.099	0.114	0.128	0.142	0.156
	180	13.5	0.054	0.068	0.081	0.108	0.135	0.162	0.189	0.216	0.243	0.270	0.297
	360	26.3	0.105	0.131	0.158	0.210	0.263	0.316	0.368	0.421	0.473	0.526	0.578
30	90	12.1	0.048	0.060	0.073	0.097	0.121	0.145	0.169	0.193	0.218	0.242	0.266
	180	23.0	0.092	0.115	0.138	0.184	0.230	0.276	0.322	0.368	0.413	0.459	0.505
	360	44.7	0.179	0.224	0.268	0.358	0.447	0.537	0.626	0.716	0.805	0.895	0.984
40	90	20.6	0.082	0.103	0.123	0.164	0.206	0.247	0.288	0.329	0.370	0.411	0.452
	180	39.1	0.156	0.195	0.234	0.313	0.391	0.469	0.547	0.625	0.703	0.781	0.859
	360	76.1	0.304	0.380	0.456	0.609	0.761	0.913	1.07	1.22	1.37	1.52	1.67

Table (6) Rack & Pinion Type/Rotary Table: MSQ Series

(L(ANR))

Size	Rotation (degree)	Volume V _A (cm ³)	Operating pressure (MPa)									
			0.1	0.2	0.3	0.4	0.5	0.6	0.7	0.8	0.9	1.0
1	190°	0.66	0.0026	0.0039	0.0052	0.0065	0.0078	0.0091	0.010	—	—	—
2		1.3	0.0052	0.0077	0.010	0.013	0.015	0.018	0.021	—	—	—
3		2.2	0.0087	0.013	0.017	0.022	0.026	0.030	0.035	—	—	—
7		4.2	0.017	0.025	0.033	0.042	0.050	0.058	0.066	—	—	—
10		6.6	0.026	0.040	0.053	0.066	0.079	0.092	0.106	0.119	0.132	0.145
20		13.5	0.054	0.081	0.108	0.135	0.162	0.189	0.216	0.243	0.270	0.297
30		20.1	0.080	0.121	0.161	0.201	0.241	0.281	0.322	0.362	0.402	0.442
50		34.1	0.136	0.205	0.273	0.341	0.409	0.477	0.546	0.614	0.682	0.750
70		50.0	0.200	0.300	0.400	0.500	0.600	0.700	0.800	0.900	1.000	1.100
100		74.7	0.299	0.448	0.598	0.747	0.896	1.046	1.195	1.345	1.494	1.643
200		145.9	0.584	0.875	1.167	1.459	1.751	2.043	2.334	2.626	2.918	3.210

Rotary Actuators Model Selection

6-2 Air Consumption Calculation Graph

Step 1 Using Graph (16), air consumption volume of the rotary actuator is obtained. From the point of intersection between the internal volume and the operating pressure (slanted line) and then looking to the side (left side) direction, the air consumption volume for 1 cycle operation of a rotary actuator is obtained.

Step 2 Using Graph (17), air consumption volume of tubing or steel piping is obtained.

- (1) First determine the point of intersection between the operating pressure (slanted line) and the piping length, and then go up the vertical line perpendicularly from there.
- (2) From the point of intersection of an operating piping tube diameter (slanted line), then look to the side (left or right) to obtain the required air consumption volume for piping.

Step 3 Total air consumption volume per minute is obtained as follows:
(Air consumption volume of a rotary actuator [unit: L (ANR)] + Tubing or steel piping's air consumption volume) x Cycle times per minute x Number of rotary actuators = Total air consumption volume

Example) What is the air consumption volume for 10 units of a CRQ2BS40-90 to actuate by operating pressure 0.5 MPa for one minute.? (Distance between actuator and switching valve is the internal diameter 6 mm tubing with 2 m piping.)

1. Operating pressure 0.5 MPa → Internal volume of CRQ2BS40-90 40 cm³ → Air consumption volume 0.23 L (ANR)
2. Operating pressure 0.5 MPa → Piping length 2 m → Internal diameter 6 mm → Air consumption volume 0.56 L (ANR)
3. Total air consumption volume = (0.23 + 0.56) x 5 x 10 = 39.5 L/min (ANR)

Inner Volume: Rack & Pinion Type

1 cycle (cm³)

Model	Rotation angle				
	90°	100°	180°	190°	360°
CRJ □ 05	0.3	0.34	0.62	0.66	—
CRJ □ 1	0.66	0.74	1.32	1.4	—
CRA1 □ 30	14.8	—	28	—	—
CRA1 □ 50	64	72	130	136	—
CRA1 □ 63	120	134	240	254	—
CRA1 □ 80	222	246	442	466	—
CRA1 □ 100	518	576	1040	1090	—
CRQ2 □ 10	2.4	—	4.4	—	8.6
CRQ2 □ 15	3.8	—	11	—	21.4
CRQ2 □ 20	14.2	—	27	—	52.6
CRQ2 □ 30	24.2	—	46	—	89.4
CRQ2 □ 40	41.2	—	78.2	—	152
MSQ □ 1	—	—	—	1.3	—
MSQ □ 2	—	—	—	2.7	—
MSQ □ 3	—	—	—	4.4	—
MSQ □ 7	—	—	—	8.4	—
MSQ □ 10	—	—	—	13.1	—
MSQ □ 20	—	—	—	27.0	—
MSQ □ 30	—	—	—	40.2	—
MSQ □ 50	—	—	—	68.4	—
MSQB 70	—	—	—	100	—
MSQB 100	—	—	—	149	—
MSQB 200	—	—	—	292	—

Inner Volume: Vane Type

1 cycle (cm³)

Model	Rotation angle					
	90°	100°	180°	190°	270°	280°
CRB □ 10-□S	1.6	—	2.4	—	3	—
CRB □ 15-□S	2.5	—	5.8	—	7.4	—
CRB □ 20-□S	8.4	—	12.2	—	15.8	—
CRB □ 30-□S	19.8	—	30	—	40	—
CRB □ 40-□S	25	—	31.5	—	41	—
CRB1 □ 50-□S	60	64	98	102	132	136
CRB1 □ 63-□S	70	73	94	97	118	121
CRB1 □ 80-□S	176	186	276	286	376	386
CRB1 □ 100-□S	372	394	562	584	752	774
MSU 1-□S	2.1	—	2.6	—	—	—
MSU 3-□S	5.0	—	6.2	—	—	—
MSU 7-□S	10.6	—	13.2	—	—	—
MSU 20-□S	26.9	—	33.6	—	—	—
CRB 10-□D	2	2.2	—	—	—	—
CRB 15-□D	5.2	5.4	—	—	—	—
CRB 20-□D	11.2	11.4	—	—	—	—
CRB 30-□D	28.8	29	—	—	—	—
CRB 40-□D	33	34	—	—	—	—
CRB1 □ 50-□D	96	104	—	—	—	—
CRB1 □ 63-□D	98	104	—	—	—	—
CRB1 □ 80-□D	272	292	—	—	—	—
CRB1 □ 100-□D	544	588	—	—	—	—
MSUB 1-□D	2.2	—	—	—	—	—
MSUB 3-□D	5.4	—	—	—	—	—
MSUB 7-□D	11.4	—	—	—	—	—
MSUB 20-□D	29.0	—	—	—	—	—

CRB □ 2

CRB1

MSU

CRJ

CRA1

CRQ2

MSQ

MSZ

CRQ2X
MSQX

MRQ

D-□

Rotary Actuators Model Selection

③-2 Air Consumption Calculation Graph

Graph (16) Air Consumption

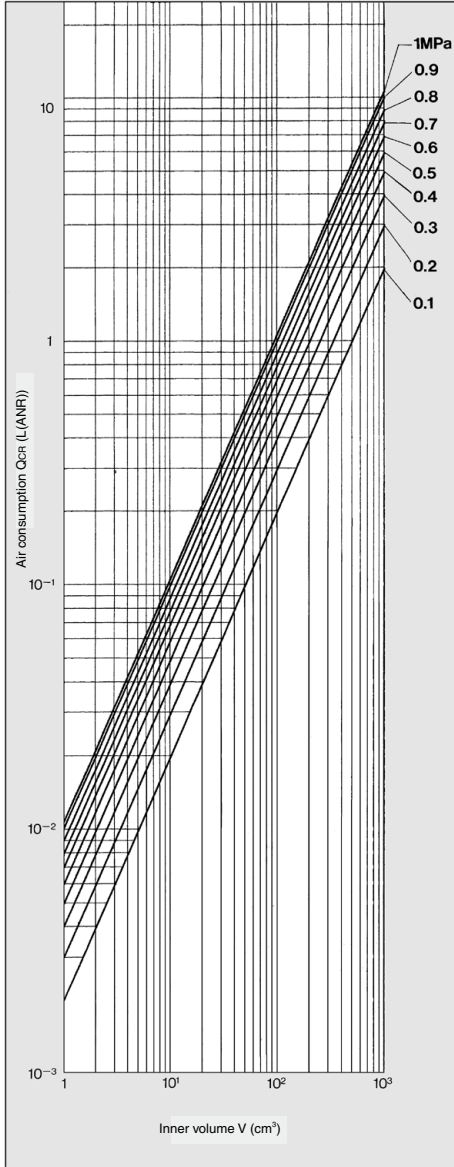

Graph (17) Air Consumption of Tubing, Steel Tube (1 cycle)

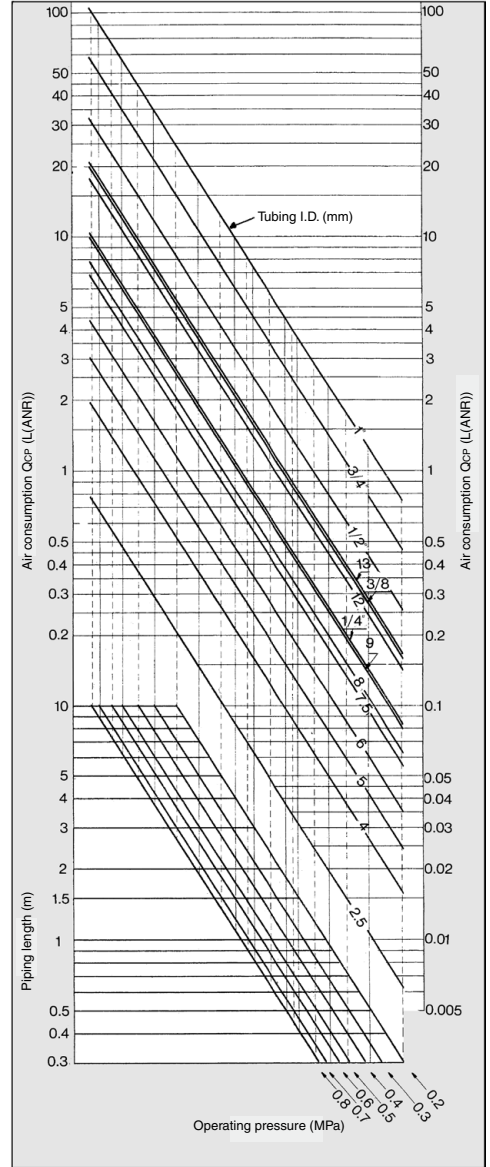

- * "Piping length" indicates length of steel tube or tubing which connects rotary actuator and switching valves (solenoid valves, etc.).
- * Refer to page 40 for size of tubing and steel tube (inner dimension and outer dimension).